



Owner's Manual

Electrolyser 4.1



Please study this manual carefully before unpacking, installing, and operating the device.

Rev. 04– August 2024



CHANGE HISTORY FOR EL4.1

Rev.	Status	Date	Revision memo	Created/changed by
00	IFI	01/10/2023	First version	Philipp Endres
01	IFI	06/10/2023	Edited/Proofread for clarity	Beth De Felici
02	IFI	06/11/2023	Updated data and fixed formatting	Beth De Felici
03	IFI	16/04/2024	Updated voltage specs / Updated fuse info / Updated O2 safety specs/ Fixed external links	Beth De Felici
04	IFI	05/07/2024	Updated KOH information / Updated images /Safety Info	Beth De Felici



Thank you for choosing Enapter. Please study this manual carefully before unpacking, installing, and operating the device.

If you have any further questions, please contact the Enapter customer support team. Quote the device serial number and hardware number on the back of the device to help identify your product quickly.

ENAPTER SRL

Headquarters: Via di Lavoria 56/G
56040 Crespina (PI) – Italy
T.: +39 050 644 281
E.: support@enapter.com
Website: www.enapter.com
VAT no. 13404981006

SCOPE OF THE DOCUMENT

This manual provides information needed to carry out the installation and usage of your Enapter device safely and as intended.

Keep this document in a safe place and readily available. Always follow its instructions. It is the operator’s responsibility to ensure that an installed device is always in proper condition. Please observe any additional local requirements applicable to the installation and operation of hydrogen devices.

APPROVED USE

This device must only be operated for its intended purpose, according to the specifications and instructions provided in this document.

Observance of this document is part of “normal use”.

Danger! Improper use of the device can result in serious injuries and damage to the environment.

- ≡ Always use the device according to the specifications described in this document.
- ≡ Ensure that the manual is always accessible.
- ≡ Make sure you have read and understood this document in its entirety.
- ≡ Comply with all safety instructions and warnings.
- ≡ Store the manual and other documentation in a safe and accessible place and pass them on to future owners and operators of the device.
- ≡ Comply with all relevant local safety guidelines, rules, directives, and regulations.
- ≡ Enapter does not guarantee efficiency, safety, and functionality in case of modifications not described in this document.
- ≡ Enapter is not responsible for any damage caused by the device or to the device based on improper operation or setup.





TERMS

The following terms are used in this document:

- ≡ **Device:** Device means the unit, including its hardware and software as well as contained materials and substances.
- ≡ **System:** System means the combination of devices, tubes, pipes and equipment from Enapter and other manufacturers which are connected physically, logically, or in any other way to produce, store, use, transfer, or convert hydrogen and related substances.
- ≡ **Operator:** The operator is the responsible person in charge who operates, installs, connects, maintains, and/or owns the device, its subcomponents, and additional components. To simplify reading, this document only refers to the operator to distinguish from Enapter but may also include the user, customer, client, owner, installer, instructor, system integrator, or persons who are responsible for safe operation of the device.



TABLE OF CONTENTS

<i>Change history for EL4.1</i>	I
Enapter Srl	II
Scope of the document	II
Approved use	II
Terms	III
<i>Table of Contents</i>	IV
1. Overview of the Electrolyser	1
1.1 Specifications	1
1.2 FRONT PANEL & Bottom	4
1.3 BACK PANEL	6
2. Safety instructions	7
2.1 Warnings and Hazards	7
2.2 General safety	8
2.3 Additional safety for the electrolyser	9
3. Hazards	10
3.1 Hydrogen hazard	10
3.2 Mechanical hazards	11
3.3 Electrical hazards	11
3.4 Chemical hazards	13
3.5 Chemical information	14
3.6 Thermal hazards	14
3.7 Environmental hazards	14
3.8 Acoustic hazards	14
4. Installation of the Electrolyser	15
4.1 Unpacking	15
4.2 Tools, material and accessories required	15
4.3 Implementing System Safety	17
4.4 Process FLOW Diagram (PFD)	18
4.5 Instructions for connecting stainless-steel pipes	19



4.6	Instructions for connecting plastic tubes.....	28
4.7	Electrical Connection Guide (POWER).....	36
4.8	Dry Contact Connection Guide (Optional) (DRY CON.).....	38
4.9	Ethernet Port (ETH.).....	41
4.10	ISO 22734 Requirements.....	42
4.11	Initial operation of the electrolyser.....	42
5.	<i>Operation of the Electrolyser</i>	46
5.1	Manual Start/Stop.....	46
5.2	Remote Start/Stop.....	46
5.3	Automatic Start/Stop.....	46
5.4	Maintenance Mode.....	47
5.5	Set Production Rate.....	47
5.6	Ramp Up.....	47
5.7	Ramp Down.....	48
5.8	Anti-Freezing Routine.....	48
5.9	Preheat Function.....	48
5.10	Safety Heartbeat.....	48
5.11	Troubleshooting.....	49
6.	<i>Enapter Monitoring Tools</i>	51
6.1	Mobile Application.....	51
7.	<i>Maintenance of the Electrolyser</i>	52
7.1	Updates.....	52
7.2	Routine Maintenance.....	52
7.3	5-year Major Maintenance.....	54
7.4	Cleaning.....	54
7.5	Disposal.....	55
7.6	Transport.....	55
8.	<i>Appendix</i>	57
	Appendix I. Hydrogen Leak Testing	57
	Appendix II. Preparing fresh electrolyte	58
	Appendix III. Draining the electrolyte	59
	Appendix IV. LED Status	61



VERSION
04

DOCUMENT TITLE
EL4.1 – Owner’s Manual

RELEASE DATE
2024-08-08

Appendix V. Error Codes 61

Appendix VI. Water Specifications 61



1. OVERVIEW OF THE ELECTROLYSER

Enapter’s patented anion exchange membrane (AEM) electrolyser is a standardized, stackable, and flexible device to produce hydrogen. The modular, easily maintainable design – paired with advanced software integration – allows set up in minutes and remote control and management.

1.1 SPECIFICATIONS

The device is available in different configurations: as an air cooled and as a liquid cooled version. Each of them has an AC version (alternating current) and DC version (direct current). The AC versions of the device are additionally available as 8 barg versions while all other devices are only available as 35 barg versions. The specifications of the electrolyser can be found in the datasheet.

It can be downloaded here: [Datasheet of the electrolyser](#).

See the battery limits for more detailed information about the interfaces and connections of the device: [Battery limits of the electrolyser](#).

Versions	Air Cooled:	Liquid Cooled:
AC-version:		
DC-version:		

	EL4.1
Nominal Hydrogen Production Rate	0.3 Nm ³ /h – 0.5 Nm ³ /h Up to 1.0785 kg/24 h
Output Pressure	Up to 35 barg
Hydrogen Output Purity	35bar: ~99.9 % (H ₂ O: 1000 ppm, O ₂ : <5ppm) at 25°C 8bar: 98,8 % (H ₂ O: 12000 ppm, O ₂ : <5ppm) at 25°C
Water Consumption	0.42 L/h
Water Input Quality	Recommended ASTM D1193-06 Type II or Type III but at least Type IV with: - Total Organic Carbon (TOC) <1000ppb



	<ul style="list-style-type: none"> - Total Silica < 500ppb - Acidity < 0.1meq/l (according to ASTM D1067) - Conductivity < 5µS/cm <2>
Water Input Pressure Range	1 – 4 barg
Process Liquid	1 % KOH solution
Operative Power Consumption	2.4 kW (beginning of life)
Peak Power Consumption	3.0 kW
Nominal Power Consumption per Nm ³ of H ₂ produced	4.8 kWh/Nm ³ (beginning of life)
Stand-by Power Consumption	0.03 kW
Power Supply	208 V – 240 V (AC), 50/60 Hz <3> 48 V – 60 V (DC)
Heat Dissipation	0.6 kW (beginning of life)
Maximum Heat Dissipation	0.9 kW (end of life)
Circuit Breaker	C13
Dimensions (W x D x H)	482 mm x 635 mm x 266 mm
Space inside cabinet	6 U
Weight	42 kg (empty) ¹ 41 kg (empty) ²
Control System Included	EMS
Communications	Wi-Fi - 802.11a/b/g/n (2.4 GHz only) - 802.12 WEP, WPA, WPA2 Personal (Pre-shared key) - Wi-Fi client isolation must be disabled Bluetooth Modbus TCP via Ethernet
Remote Control	Enapter Cloud Service, Enapter App, Modbus TCP, Safety chain (dry contact)
Safety	
Maximum H ₂ contained within	20 NL
Conformity	CE mark according to the machine directive 2006/42/CE UKCA mark according to Supply Machinery (Safety) Regulations 2008 CSA/ANSI B22734:2023 Ed.1 Hydrogen Generators Using Water Electrolysis - Industrial, Commercial, and Residential Applications ⁴
Legislation and standards	Machinery Directive and relevant harmonized standards: 2006/42/CE; ISO 12100 Low Voltage Directive and relevant harmonized standards: LVD 2014/35/UE; EN IEC 61010-1 EMC directive and harmonized standards: EMC 2014/30/UE; IEC 61326-1



	Radio equipment directive and harmonized standards: RED 2014/54/UE; EN 300 328 Restriction of hazardous substances directive RoHS II 2011/65/EU, delegate directive UE 2015/863 and directive 2017/2102
Noise level at 1 m	<85 dB
Ventilation and Safety Recommendation	To be installed in a safe (non-hazardous) area only. Indoor: Ventilation depends on the room size. A hydrogen detection system with a safety circuit is mandatory. Outdoor: Protect from outside environmental influences if integrated into a cabinet. Ensure the safety concept of each integrated module is respected.
Environmental	
Operating Conditions	5 °C to 45 °C, up to 90% humidity, non-condensing.
Storage Conditions	2 °C to 55 °C, up to 90 % humidity, non-condensing Contact the Enapter customer support team if storing the device longer than 30 days.
IP Rating	IP 20
Interfaces	
H ₂ Outlet	¼” bspp female port
O ₂ Vent Outlet	⅜” bspp female port
H ₂ Vent Outlet	¼” bspp female port
H ₂ O Inlet	10 mm push-fit female bulkhead connector
Fill / Drain Port	10 mm CPC quick connector
Cooling Water Inlet ²	10 mm push-fit female bulkhead connector
Cooling Water Outlet ²	10 mm push-fit female bulkhead connector

¹ Air Cooled electrolyzers only (Liquid cooled versions excluded)

² Liquid Cooled electrolyzers only (Air cooled versions excluded)

⁴ ETL certified electrolyser versions only.

NOTE: The product is under continuous improvement and the technical specifications might be subject to change. Please make sure to refer to our website for the most recent specifications.



1.2 FRONT PANEL & BOTTOM

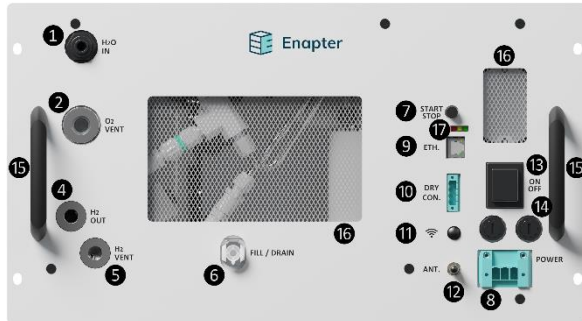

EL4.1 AC air cooled front side

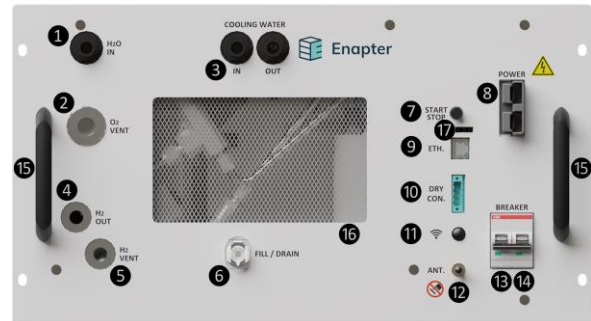

EL4.1 DC liquid cooled front side.

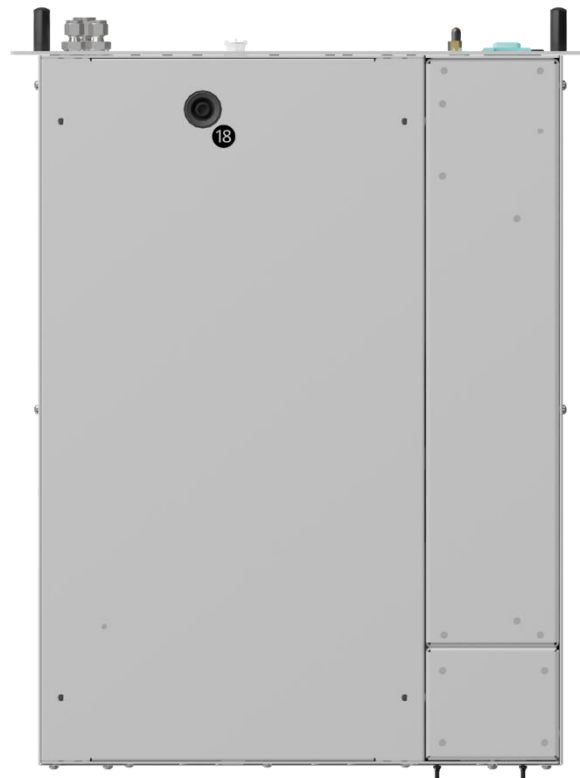

EL4.1 air cooled bottom view

The front panel includes most of the physical connections of the device. The leakage drain hole is positioned on the bottom of the device. For more information, please refer to the [battery limits](#).

1. H₂O IN – please refer to the [Water Inlet Connection Guide \(H2O IN\)](#)
 - ≡ Push-fit female bulkhead connector (10 mm outer diameter pipes) POM (Polyoxymethylene)
 - ≡ Input: Filtered water (please refer to the Water Input Quality in chapter 1.1) input pressure between 1 and 4 bar
2. O₂ VENT – please refer to the [Oxygen Vent Connection Guide \(O2 VENT\)](#)
 - ≡ 3/8" bspp female port. Do not use NPT fittings.



- ≡ Output: 0.25 Nm³/h O₂ at up to 58 °C with 10-38 g/h water (H₂O) and traces of H₂
- 3. COOLING WATER IN/OUT – (only liquid cooled electrolysers) please refer to the [Cooling Loop Connection Guide \(COOLING WATER IN/OUT\)](#)
 - ≡ Push-fit female bulkhead connector (10mm outer diameter pipes) POM (Polyoxymethylene)
 - ≡ Input/Output: cooling water to cool down the device.
- 4. H₂ OUT – please refer to the [Hydrogen Outlet Connection Guide \(H2 OUT\)](#)
 - ≡ ¼" bspp female port. **Do not use NPT fittings.**
 - ≡ Output: 0.5 Nm³/h of H₂, up to 35 barg, 99.9% purity (35 barg version) or 98.8% (8 barg version)
- 5. H₂ VENT – please refer to the [Hydrogen Vent Connection Guide \(H2 VENT\)](#)
 - ≡ ¼" bspp female port. **Do not use NPT fittings.**
 - ≡ Output: Periodical vent of up to 20 NL (H₂ and water) every 6 h (35 barg version) or every 1.5 h (8 barg version)
- 6. FILL / DRAIN – please refer to the [Electrolyte Filling](#) section below.
 - ≡ 10 mm CPC quick connector. During maintenance routine for filling the electrolyte into the device or for draining and preparing it for transport. Before draining the device through its dedicated port, wear appropriate personal protective equipment (PPE). For more information, refer to [Appendix III](#) below. Collect the electrolyte in an appropriate container and place it in a chemical waste container. It contains 1.54 % of KOH if filled according to this manual.

Please protect the environment: Do not flush into the sewer. Dispose of the liquid in compliance with all relevant local safety [guidelines](#), rules, directives, and regulations.
- 7. START STOP – please refer to the [Manual Start/Stop](#) section below.
 - ≡ Manual start and stop button to start and stop the device.
- 8. POWER – please refer to the [Electrical Connection Guide \(POWER\)](#)
 - ≡ Manual power button to switch device on and off.
- 9. ETH. – please refer to the [Ethernet Port \(ETH.\)](#) section below.
 - ≡ Interface to access external Modbus control features of the electrolyser.
- 10. DRY CON. – please refer to the [Dry Contact Connection Guide \(Optional\) \(DRY CON.\)](#)
 - ≡ Interface to connect device to external sensors for emergency stops.
- 11. WiFi Button – please refer to the [Pairing the device to the cloud](#) section below.
 - ≡ Manual button to activate/deactivate WiFi.
- 12. ANT. – Antenna port SMA male – please refer to the [Pairing the device to the cloud](#) section below.
 - ≡ The device can be connected to the local network via Bluetooth and Wi-Fi, enabling real-time updates and monitoring for the operator via the Enapter App and cloud. A miniature antenna can be attached to this port to increase the amplification.
 - ≡ Do not touch the port when the device is powered on!
- 13. On/Off Button (only in AC version) or Breaker (only in DC version) – please refer to the [Electrical Connection Guide \(POWER\)](#)
 - ≡ Integrated magnetothermal circuit breaker to protect the electrolyser from overcurrent and short-circuits.



14. Thermal overcurrent circuit breakers (only in AC version) or Breaker (only in DC version) – please refer to the [Electrical Connection Guide \(POWER\)](#)
 - ≡ Integrated magnetothermal circuit breaker to protect the electrolyser from overcurrent and short-circuits.
15. Handlebars – for easier transport
16. Air Inlets – please refer to the [Routine Maintenance](#) section below.
 - ≡ Keep the air inlets free of dust and dirt.
17. LEDs – please refer to the [LED Status](#) section below.
 - ≡ Status LEDs to show device status.
18. Leakage Drain Hole – please refer to the [Troubleshooting](#) section below.
 - ≡ The leakage drain hole allows the operator to drain the tray in case of electrolyte or water leakage.

1.3 BACK PANEL

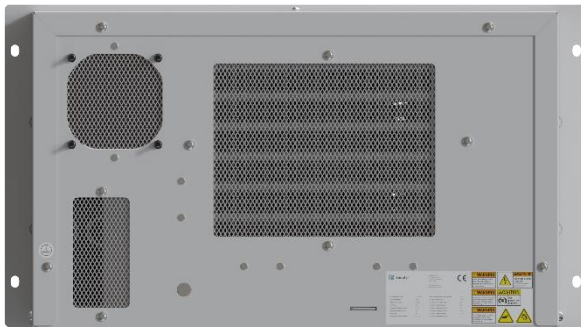

EL4.1 air cooled back side

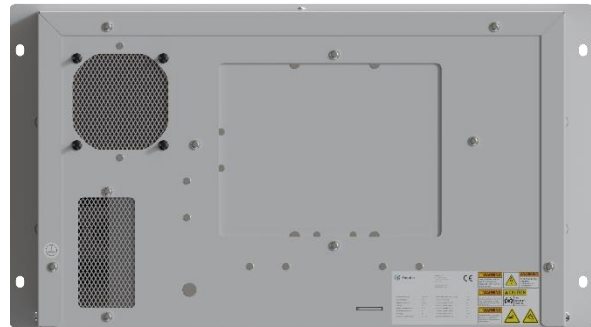

EL4.1 liquid cooled back side

The back panel of the device is used to blow out warm air. The stickers show the device specifications and serial number details.



Notice! Never obstruct the ventilation openings to avoid overheating!

Clean the ventilation openings regularly to avoid dust and bigger obstacles from blocking the inlets and outlets of the internal ventilation system.

Please leave at least a 30 cm space behind the module to allow adequate airflow.



2. SAFETY INSTRUCTIONS

2.1 WARNINGS AND HAZARDS

The following terms and symbols are used in this manual to indicate important text passages which must be given particular attention:



Warns of fatal/serious injuries or death



Warns of injury



Warns of physical damage to the product



Warns of explosions



Do not open or dismantle



Keep away from sources of heat and ignition.
No naked flames



No smoking



Minimum two persons required to handle the item



Wear personal protective equipment (PPE)



Wear hearing protection



Button cell or coin battery safety warning <4>



Keep out of reach of children <4>



2.2 GENERAL SAFETY



Serious injuries and death, as well as damages to the product or the environment possible! Follow the instructions in this manual carefully!

The operator must be aware of the following:

1. **The device is not intended to be used in a potentially explosive area.**
2. **Enapter is not responsible for improper use:**
 - ≡ Caused by inaccurate input.
 - ≡ Caused by inaccurate input pressures.
 - ≡ Caused by improper mounting or piping (e.g., leaking gas connections)
 - ≡ Caused by connecting the wrong power supply (e.g., wrong voltage)
 - ≡ Caused by improper installation.
3. Regarding design and installation, the operator must **follow Enapter’s installation rules**, and **ensure full compliance** with all relevant local safety guidelines, rules, directives, and regulations.
4. The operator must check the device for hydrogen, water, and KOH leakages regularly and ensure that all interfaces are connected correctly.
5. It is the operator’s responsibility to regularly check and maintain all outlet lines and keep the pipes free of ice, other obstructions, or overpressure.
6. It is the operator’s responsibility to regularly check and clean the air intakes and outlets of the device and to keep them free of obstructions.
7. If larger hydrogen systems are created by putting together several modules, it is the operator’s responsibility to ensure full compliance of the final assembly with all relevant local safety guidelines, rules, directives, and regulations.

The following rules should always be observed:

1. **Keep the work area clean.** Clutter can create hazards around the device. Keep the work area well illuminated.
2. **Do not use the device in an explosive atmosphere.** Do not use the device near flammable substances.
3. **Handle the power supply cable and plug with care.** Do not pull the electric cable to disconnect it from the plug without removing power from it first. Keep the electric cable away from heat, oil, water, and sharp edges.
4. **Protect yourself from electric shocks.** Avoid any contact with earthing surfaces.
5. **Never expose the device to rain or damp conditions.**
6. **Keep children and people without explicit knowledge of the device and its function away** at a safe distance.
7. **Never operate the device in confined spaces** without additional safety infrastructures, such as active ventilation and hydrogen detection systems.
8. **Always protect yourself:**
 - ≡ **Wear protective goggles and nitrile gloves** when handling the electrolyte solution.
 - ≡ **Wear ear muffs or plugs** in noisy areas.



- ≡ **Wear gloves** when handling the device.
 - ≡ **Wear appropriate footwear** when handling the device.
 - ≡ **Use lifting aids** if available when lifting the device. Never lift the device alone. Know your local and site-specific health and safety rules and act accordingly.
9. **Always disconnect the device from electricity before cleaning, disassembly, and transport.**
 10. **Only use the device in the way and for the purposes mentioned in this manual.** If the device is employed for uses other than what is specified in this manual, unforeseen hazards may occur.
 11. **Use the handles when lifting and moving the device.**
 12. **Never attempt to repair the device** by yourself. The device must only be repaired by qualified specialists who use original spare parts.
 13. Any maintenance activity, excluding the ones listed in the routine maintenance and installation sections, is only allowed to be performed by authorized **trained technicians!**
 14. Any person working on the device **must be familiar and trained** with the hazards and risks associated with installing, commissioning, and running the device and attached devices.
 15. **Do not store the device at temperatures below 1°C.**

2.3 ADDITIONAL SAFETY FOR THE ELECTROLYSER

This device contains a SIL1 Safety Instrumented System (SIS) within, managing inner safety instrumented functions (SIF). The SIS is accompanied by a Safety Manual, an addendum to the Owner’s Manual, to be used in conjunction with it. It provides all the functional safety-relevant information necessary for the operator to verify the required skills and instructions to install, verify, maintain, and periodically test the system, ensuring the respect for product safety requirements (item function, input/output interfaces etc.).



Serious injuries and death as well as damages to the product or the environment possible! Follow the instructions in this manual carefully!

Ignoring the Safety Manual instructions could impair the safety functions performance.

In addition, the following rules should always be observed. It is the operator’s responsibility to ensure that every person working with the device is following these rules:

1. Do not attach filled tanks or other equipment with **pressures higher than the device’s maximum outlet pressure** to the H₂ outlet of the device.
2. Do not provide water which does not meet the **minimum purity requirements**.
3. Do not provide water with a pressure higher than the **maximum allowed pressure**.
4. Make sure that the H₂ vent line and the O₂ vent line are **never obstructed and never combined**.
5. **Do not combine the O₂ vent line of the EL4.1 with the O₂ vent line or other pipes of older models.**



3. HAZARDS

The operator who operates, services, maintains, or installs this device must be aware of the potential dangers associated with its use and set up, the required materials, as well as the inputs and outputs, to implement sufficient countermeasures and processes to prevent accidents and act correctly in case of emergencies.

Serious injuries and death as well as damages to the product or the environment possible! Follow the instructions in this manual carefully!



Always ensure that the device is installed and operated in compliance with all relevant local safety guidelines, rules, directives, and regulations. Do not install, operate, or maintain the device without explicit knowledge or help from experienced and licensed system integrators, the manufacturer, or external certifying bodies.

3.1 HYDROGEN HAZARD

It is the operator’s responsibility to implement a safety system to manage the devices’ inputs and outputs – more information about this is below.

Danger! Hydrogen is a highly explosive and volatile gas!

Hydrogen can explode! Do not mix hydrogen with oxygen or air! Prevent hydrogen from leaking! Even small leakages will create flammable and explosive environments!

Prevent electrostatic charging of the device. Hydrogen ignites very easily!

Do not inhale hydrogen!

Hydrogen can cause asphyxiation!



Hydrogen is very volatile. Still, it can accumulate in areas and materials that are unexpected. Do not handle hydrogen without a suitable ventilation and safety system!



Incorporate the device, especially the hydrogen and the vent lines, into the operational safety concept and comply with all relevant local safety guidelines, rules, directives, and regulations.

Avoid heat in the vicinity of the device.



Do not smoke or have naked flames in the vicinity of the device.

Do not have hydrogen, not even in low concentrations, in the vicinity of the device.

The hydrogen which comes out of the device is under pressure! Comply with all relevant local safety guidelines, rules, directives, and regulations for the handling of compressed hydrogen.

In the case of escaping gas, stay away and keep inflammable materials away.

Ensure proper installation of the supply pipes.

Check the hydrogen lines and connectors regularly for leakages.



3.2 MECHANICAL HAZARDS

It is always necessary to wear appropriate personal protective equipment (PPE) and use suitable tools when handling the device and packaging material.

Some general training regarding lifting heavy loads and safety briefings are required to perform the tasks safely described in this manual.

Operators must comply with the general safety principles during the handling phases. In particular:

Caution! The device is heavy!



Before handling, moving, and commissioning the device, assess the hazards of the operation and study the manual. Appropriate PPE must be worn, such as cut resistant gloves, safety shoes, protective goggles, etc. depending on the activity.



Clear the area of work before starting to mount the device.

The device is heavy and must be lifted by at least 2 people – plan around this and allow ample space to move around.

Do not lift the device over your head.

Caution! Handle the device with care!



During handling of the device, be cautious and use the handles on the device to minimize the mechanical risks, such as:

- ≡ Impacts and crushing injuries due to uncontrolled movements of the load.
- ≡ Dropping the device, causing crushing injuries
- ≡ Loss of stability, leading to entanglements and other injuries.

The packaging/device must be handled by at least two people.

3.3 ELECTRICAL HAZARDS

The device poses no special electrical hazards if the following instructions on safety measures are followed, and the Electrical Connection Guide below is applied correctly:

Warning! The device requires an electrical power supply!



≡ Handle the electrical installation with care. Ensure that the power plug is fastened and fixed correctly into the socket to avoid any loosening of the wiring.

≡ The power plug is not double insulated. Therefore, it could become hazardous in single fault conditions. Make sure to disconnect the upstream power source before touching the power plug.

≡ Use only the supply voltage specified for the device.

≡ Do not short-circuit inputs and outputs.

≡ Do not reverse the polarity of inputs and outputs.

≡ Do not insert any mechanical parts, especially metal parts, into the device through the ventilation slots or other openings.

≡ Do not use liquids near the device.



VERSION
04

DOCUMENT TITLE
EL4.1 – Owner’s Manual

RELEASE DATE
2024-08-08

- ≡ Never use the device if any part of it has been immersed in water.
- ≡ Do not touch the antenna when the device is powered on, ensure being electrostatically discharged when mounting/dismounting the antenna.



Warning! Explosion hazard! Do not remove or replace the power supply plug while circuit is live unless the area is free of ignitable concentrations.



Warning!

Always turn off the power supply when the device is being cleaned, maintained, or transported. Any servicing, other than cleaning and routine user maintenance, must be performed by trained, Enapter-endorsed technicians.



3.4 CHEMICAL HAZARDS

Potassium Hydroxide is used in the electrolyser as the main process liquid (electrolyte). The electrolyte usually comes pre-mixed with the electrolyser, but it can also be purchased as a powder to be diluted in purified water.

Caution! The device contains chemicals!



Refer to the Material Safety Data Sheet (MSDS) of all chemicals used before handling them. All persons mixing, draining, and handling the electrolyte must be informed about the chemicals and potential hazards.

Caution! Protect yourself!



Wear appropriate personal protective equipment (PPE). Avoid contact with eyes and skin.



If you got in contact with the solution, immediately wash the affected area and refer to the material safety data sheet of potassium hydroxide supplied with the electrolyser. <4>



Ensure all material used to store the electrolyte solution is chemically compatible with it.



Caution! Contains button cell or coin battery! Warning of ingestion hazard!

INGESTION HAZARD: This product contains a button cell or coin battery.

DEATH or serious injury can occur if ingested.

A swallowed button cell or coin battery can cause **Internal Chemical Burns** in as little as **2 hours**.

Keep new and used batteries **OUT OF REACH of CHILDREN**.



Seek immediate medical attention if a battery is suspected to be swallowed or inserted inside any part of the body. <4>

In the event of physical contact with the undiluted substance, refer to the material safety data sheet of potassium hydroxide and follow the instructions below.

First Aid Recommendations



- ≡ In the event of skin contact, take off contaminated clothing immediately. Wash off with soap and plentiful water. Consult a doctor.
- ≡ In the event of eye contact, rinse carefully with plentiful water for at least 15 minutes and consult a doctor.
- ≡ If ingested, do not administer anything to people that have fainted. Rinse mouth with water. Consult a doctor immediately.



3.5 CHEMICAL INFORMATION

Substance: Potassium Hydroxide

CAS no.: 1310-58-3

EC no.: 215-181-3

Classification: C.

R Phrases: R22, R36/38, R43, R42

S Phrases: S24-37, S39, S62

(see Safety Material Data Sheet included in the shipment)

3.6 THERMAL HAZARDS

Thermal hazards such as burns and scalds from contact with high-temperature surfaces can be prevented by following these safety instructions:

Caution! Parts of the device and attached pipes and connectors become very hot!



- ≡ Never open the device unless being specially trained for service by Enapter.
- ≡ Do not touch the O₂ vent port or any attached pipes directly after operation. Switch off the device and wait until it is cooled down before servicing, transporting, or changing the piping of the device.

3.7 ENVIRONMENTAL HAZARDS

The device was designed for use in standard ambient conditions, respecting stability requirements (without seismic or hydrogeological events).

The device has not been designed for outdoor use. It is the operator's responsibility to protect the device and all its accessories against atmospheric phenomena such as direct sunlight, rain, snow, and lightning.

3.8 ACOUSTIC HAZARDS

According to the requirements stated into the Machine Directive 2006/42/EC, the following topics have been considered:

Caution! The device vents gases with a loud noise!



During regular operation, the device emits a noise level below the maximum acceptable threshold for long time exposure (80 dBA).



However, a sudden vent (either caused by device shut down or unforeseen error) can be louder than 85 dB, depending on the vent line installation. Due to this, Enapter recommends wearing PPE (earplugs) while working around the device.



4. INSTALLATION OF THE ELECTROLYSER

Any person working on the device must be familiar with the hazards and risks associated with installing, commissioning, and running it. The device is a non-portable device. It must be installed in a secured, fixed horizontal position to prevent accidental movement or dropping.

4.1 UNPACKING

The device has been carefully inspected and tested before shipping. Visual checks for damage and functional tests should be performed upon receipt. Please also check the yellow tilt watch stickers on both sides of each carton box. If one or both have been triggered at more than 50°, please contact the Enapter customer support team. During transport, installation, packaging, or unpacking, do not tilt, shake, or turn the device by more than 50° to avoid damage. Do not install the device on an inclined position of more than 10°. The device must be installed on static ground, free of vibrations and shaking.

Please remove the thin foil that covers the chassis before mounting the device in its final position. Make sure to not remove the warranty labels on the backside when removing the foil.

Please do not dispose of the original shipping materials. Enapter will not accept devices for repair or replacement if they are returned without the original shipping boxes or equivalents for safe transport. If the shipping boxes cannot be kept, please recycle responsibly.

Notice! The device might get damaged when not transported appropriately!



If any damage has occurred during transport, please report this immediately to the shipping agent and supplier. Afterwards, the device should be returned according to the shipping instructions provided in this manual, in the section “Transport, Maintenance and Recycling”.

Caution! The device is heavy!



Never lift the device out of the packaging alone. The device weighs over 40 kg. Please see the datasheet for more details.

Use lifting aids if available.



Due to their weight and size, it is recommended to use a pallet cart or similar devices to maneuver the box upon delivery.

If the box must be lifted somewhere, always lift with at least two people.

4.2 TOOLS, MATERIAL AND ACCESSORIES REQUIRED

The following tools, equipment, and material are needed to connect the device successfully. Ensure the material chosen for this task is compatible with hydrogen operation.

4.2.1 TOOLS

- ≡ Wrenches depending on the pipes and connectors.
- ≡ Plastic pipe cutter (to cut the H₂O pipe)
- ≡ Slotted screwdriver (to screw in the power supply plug)



- ≡ Stainless-steel pipe cutter (to cut the H₂ Out, H₂ vent, and O₂ vent pipe)
- ≡ ¼” and ⅜” tube bender (to bend the H₂ Out, H₂ vent, and O₂ vent pipe)



4.2.2 MATERIAL

It’s the operator’s responsibility to choose the correct material according to the individual setup and all relevant local safety guidelines, rules, directives, and regulations.

- ≡ L-pieces, I-pieces and T-pieces for the POM (Polyoxymethylene) and stainless-steel pipes
- ≡ H₂O IN:
 - ≡ Push-fit locking clips for 10 mm pipes (to fix the pipes within the connectors).
 - ≡ 10 mm diameter POM (Polyoxymethylene) tubing (ensure the tubing is pressure-resistant to at least 4 bar!).
- ≡ H₂ OUT/VENT:
 - ≡ ¼” stainless-steel tube fitting male ISO parallel thread connectors. Do not use NPT fittings.
 - ≡ Stainless-steel pipes AISI 316L - ASTM A269 with at least ¼” outside diameter or equivalent material in terms of tightness, resistance to corrosion, hydrogen embrittlement, fire conditions, and the required pressures of at least 45 barg.
- ≡ O₂ VENT:
 - ≡ ⅜” stainless-steel tube fitting male ISO parallel thread connector. Do not use NPT fittings.
 - ≡ Stainless-steel pipes AISI 316L - ASTM A269 with at least ⅜” outside diameter or equivalent material in terms of tightness, resistance to corrosion and temperature, and fire conditions.



4.2.3 ACCESSORIES (INCLUDED IN THE BOX)

- ≡ Electrolyte filling bag with pipe and connectors (labelled)
- ≡ AC male connector for electricity
- ≡ Green DRY CON jumpers
- ≡ Antenna for increased amplification of wi-fi
- ≡ Black ferrite cylinder for the Dry Contact output cable
- ≡ Check valve for the H₂ vent line.
- ≡ Filter for the water inlet pipe, 10 mm pipe diameter



4.3 IMPLEMENTING SYSTEM SAFETY

Each connection to and from the device must be inspected and tested. Additional system engineering might be required to ensure safe operation.

Always follow best practices, apply local codes of regulation (if applicable), and follow industry standards for the implementation of safety systems to manage the risks of producing and storing hydrogen.

Gas containing pipes must be properly connected to the specific ports, tested by the operator, and directed to separate safe areas. If this is not possible, the operator must find another safe solution, such as using a flare stack, burn box, or forced dilution. When forced dilution is utilized, all components used in this process must not be able to ignite the hazardous substances.

Danger! The device produces explosive and highly volatile gases!

It is the operator’s responsibility to ensure good engineering practices are applied to the hazardous substances which are released during the operation of the device!



The operator must ensure that the outlet satisfies all relevant local safety guidelines, rules, directives, and regulations in terms of the safe dispersion of the vented gas, noise emission, risk assessments, maintenance, a satisfactory safety concept being utilized, and all other relevant areas.

It is the operator’s responsibility to regularly check and maintain all pipes.

4.3.1.1 SAFETY AREAS AROUND THE O₂ VENT AND H₂ VENT OUTLET

Generally, there are two options. The extents of this safety area depend on different parameters, for example, the diameter and the length of piping leading to the safe area, the vent spout design, exit velocity, and wind conditions.

Preferably, the operator:

1. Calculates the measurements of the safety area based on the provided data for each specific output and applies industrial standards such as the following to their system design, safety concept, and site documentation.
 - ≡ EIGA Doc 211/17: Hydrogen Vent Systems for Customer Applications
 - ≡ CGA G5.5: Hydrogen Vent Systems
 - ≡ EIGA Doc 154/16: Safe location of oxygen and inert gas vents
 - ≡ ISO/TR 15916:2015: Basic considerations for the safety of hydrogen systems



- Or follows the recommendations of Enapter for systems consisting of up to ten (eight⁴) electrolysers and two dryers. The safety area is cylindrical and has a height of 10 meters and a radius of 5 meters. Note that depending on the design of the vent piping and exit velocity, this area also extends in the direction of the ground by at least 1 meter. Never place the O₂ vent outlet near the H₂ vent or H₂ purge outlet to minimize the risk of explosion. Leave at least 3 meters of space between the gas outlets.

⁴ ETL certified electrolyser versions only

4.4 PROCESS FLOW DIAGRAM (PFD)

The following diagram shows internal components of the device as well as how it interacts with the Enapter Dryer and the Enapter Water Tank. It is also available [here](#). Please note that the diagram is slightly simplified to be more understandable and to protect Enapter’s intellectual property.

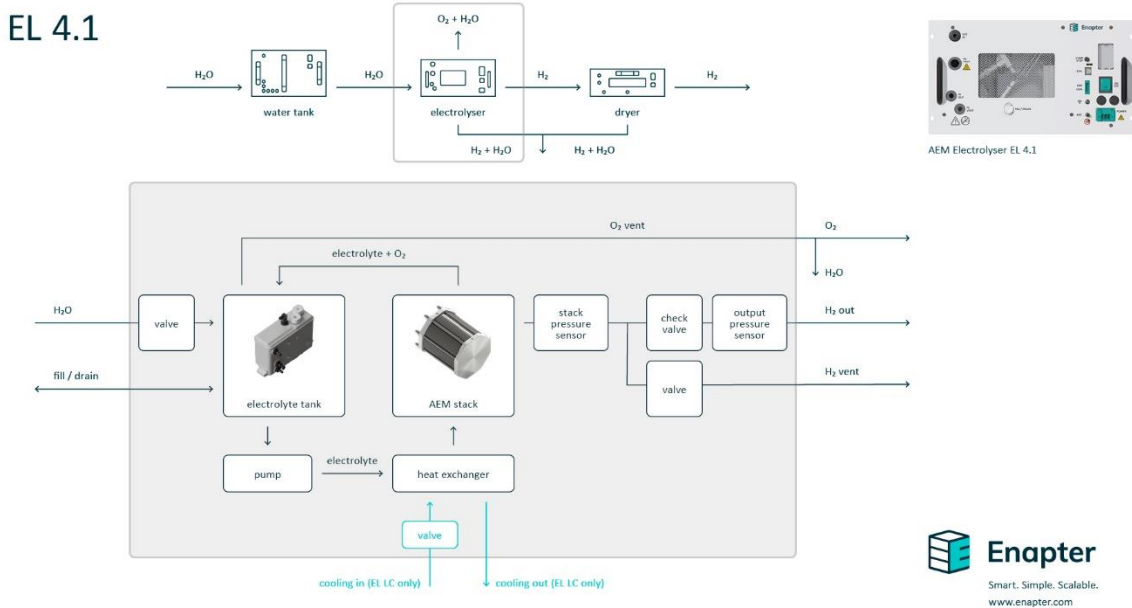

PFD of the EL4.1



4.5 INSTRUCTIONS FOR CONNECTING STAINLESS-STEEL PIPES

Attach all pipes first before starting the hydrogen production.

The stainless-steel connections need tube fittings with ¼” outside diameter for the H₂ pipes and ⅜” outside diameter for the O₂ pipe. The outlets to be connected according to these instructions are labelled “H₂ OUT” and “H₂ VENT”, as well as “O₂ VENT” on the front panel of the device.

Follow the instructions of the fittings manufacturer carefully to install leak-tight connections. Cut the pipes perpendicular to the required length. Make sure that the pipes are not under tension. Ensure the pipe is free of score marks, the cut is perpendicular across the tube, and remove sharp edges. Properly clean and flush the pipes, especially if they have been in contact with dust, dirt, or cutting particles. Make sure that the pipes are not getting in contact with oil or other liquids before or during the installation. Contamination inside the pipes may damage the device and connected components.

Always check each connection for leaks! Metal to metal fittings can be used but remounting them is not recommended due to possible leakages. For more information, please refer to [Appendix I](#) below.

4.5.1 HYDROGEN OUTLET CONNECTION GUIDE (H₂ OUT)

Connect the H₂ Out port, located at the bottom left of the front panel, to a hydrogen storage tank or the Enapter Dryer. It is recommended to fit a shut-off valve between the tank and the dryer to be able to isolate each component during maintenance.

Multiple electrolyzers can be connected to a common line by combining the electrolyzers in a 19” rack via a common output line to the left of the devices and then connecting this H₂ line with the lines of other racks. Adapting the pipe diameters to the maximum output is required.

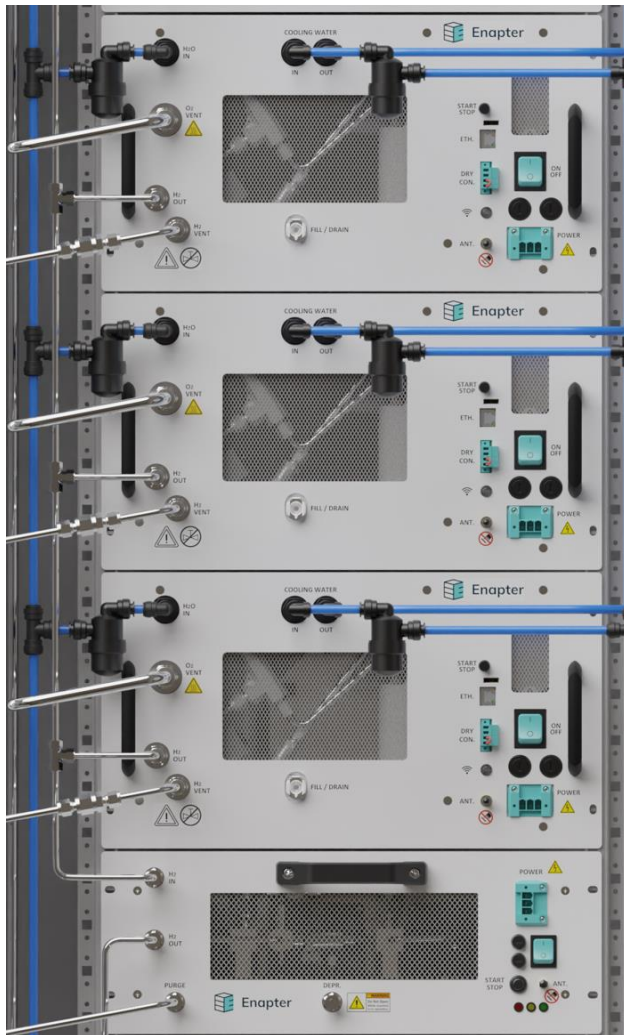

Three EL4.1 with common H₂ OUT connected to a DR2.1



Details

Danger! Explosive gases in pressurized pipes!



All pressurized connections must be inspected and checked for leakages.

Failure to do so significantly increases the risk of explosion.

All pressurized pipes must be free of metal swarf, obstructions, and other particles as they might cause injuries and damage, especially when the pressure inside the pipe is released too quickly.

Make sure to install a pressure relief device between the device’s H₂ Out port and the H₂ storage or other downstream equipment to protect the devices from overpressure.

Enapter is not responsible for any damage caused by improperly installed equipment. Please be aware that when larger hydrogen systems are created by putting together several modules, the piping downstream may have to be sized accordingly. It is the operator’s responsibility to ensure adequately sized piping is selected, which does not limit the air flow. The operator must ensure that the outlet satisfies all relevant local safety guidelines, rules, directives, and regulations in terms of the safe handling of the



produced gas, noise emission, risk assessments, maintenance, satisfactory safety concepts being utilized, and all other relevant areas.

It is the operator’s responsibility to regularly check and maintain all pipes.

Please contact the Enapter customer support team for questions regarding the piping.

4.5.2 HYDROGEN VENT CONNECTION GUIDE (H₂ VENT)

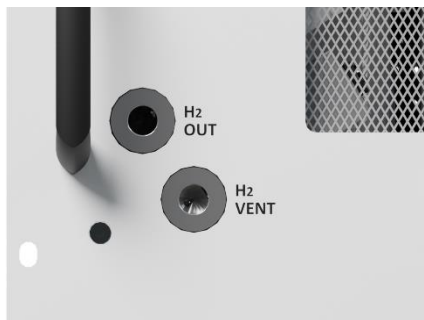

H₂ OUT and H₂ VENT

Connect the H₂ vent port, located at the bottom left of the front panel, to your hydrogen vent outlet.

During ramp-up, after ramp down and every 6 h (35 barg version)/every 1.5 h (8 barg version) during operation, the electrolyser depressurizes and releases up to 20 NL (35 barg version)/5 NL (8 barg version) of hydrogen within 2 seconds with a loud noise through the vent line. Please wear PPE earplugs when close to the devices. Venting is necessary to release the water which has been extracted from the hydrogen.

The released hydrogen will pose a risk of explosion – therefore, it must be led into a safe area with appropriate ventilation at a height of at least 3 m without any source of possible ignitions. For more information, see the section [Safety areas around the O₂ vent and H₂ vent outlet](#). If this is not possible, manage the vent line in other ways, such as using a flare stack, burn box, or forced dilution.

The contained check valve must be installed downstream of the electrolyser output and replaced if defective. Enapter recommends exchanging the check valve once per year.

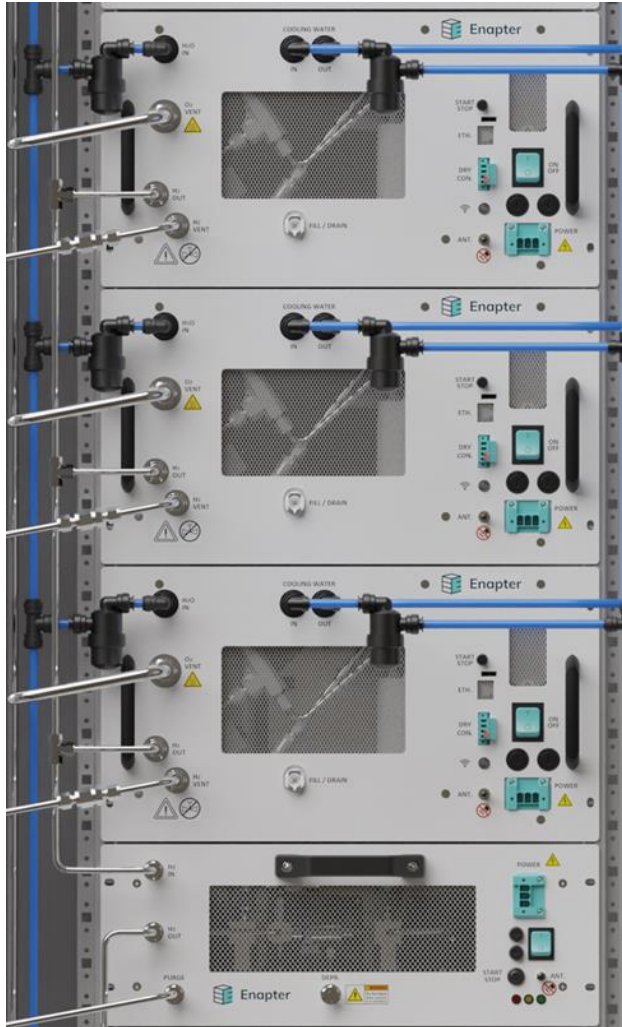

Three EL4.1 and a DR2.1 with common H₂ VENT



Details



Danger! Risk of explosion!

Never mix the output of the H₂ vent line with the output of the O₂ vent line.

The H₂ vent line can be combined with the H₂ purge line of the Enapter DR2.1 using the provided check valve downstream from the electrolyser’s H₂ vent port.

Make sure that there is never built-up pressure of more than 0.2 barg inside the pipe and that it is always open to the atmosphere! Otherwise, the device will get permanently damaged.

The line contains water steam and liquid water which can freeze and block the pipe. Install the check valve which is provided with each device directly at the H₂ vent output. The pipe of each device and the common pipes for several devices must be sized appropriately and managed with an appropriate drainage system and good engineering practices to always allow the gas to flow while still draining the water safely.



The operator must ensure that the outlet satisfies all relevant local safety guidelines, rules, directives, and regulations in terms of the safe dispersion of the vented gas, noise emission, risk assessments, maintenance, satisfactory safety concepts being utilized, and all other relevant areas.

It is the operator’s responsibility to regularly check and maintain all pipes.

Enapter is not responsible for any damage caused to the device from mismanaged piping arrangements.

To connect the port labelled “H₂ Vent”, use H₂, KOH and pressure resistant pipes, sealings, and connectors only. If connecting several devices to a common vent line, make sure the diameter of the line is sufficient and that it always runs at a downward angle. As water is condensing inside the vent lines, there must not be any horizontal or sagging sections. The water condensation would block the pipe. Pipes outside of the container or rack, or far away from it, are often facing colder temperatures and therefore more condensation, which leads to a higher amount of liquid water. The lowest point of the vent line should therefore be located where the water condensation is accumulating. Bigger pipe diameters and low flow velocities help to drain the condensed water safely.

At this lowest point with low flowrates where the condensed water is trapped, a drain trap or similar device must be installed to separate the condensed water from the hydrogen.

Remember that each local lowest point, sagging, or horizontal section requires an additional drain trap or similar device.

Make sure that water cannot flow back to the devices. The vent outputs must not be the lowest points of the pipe.

4.5.2.1 OXYGEN VENT CONNECTION GUIDE (O₂ VENT)

Connect the “O₂ Vent” port, located at the top left of the front panel to your oxygen vent outlet.



EL4.1 H₂O IN and O₂ VENT

The O₂ vent line requires the most demanding line management. Please study this section carefully. The oxygen vent line carries around 0.25 Nm³/h of oxygen at up to 58 °C out of the electrolyser. Crossover in normal operation is under 3%, in the production range 60%±100%, up to 30 barg (at the beginning of life). In transient conditions (such as ramp-up and ramp-down) and in the event of stack failure, a flammable mixture shall be expected and managed accordingly (venting to a safe area without ignition sources along/around the vent system).

Danger! Risk of explosion!

Never mix the output of the H₂ vent line with the output of the O₂ vent line.

Do not combine the O₂ vent line of the EL4.1 with the O₂ vent line of older models.

This line contains hot gases! Handle the output and the pipe with care, use insulation or proper shielding if necessary, and do not touch it during or directly after the operation as the pipe itself, connected parts, and the gases at the outlet are hot and can create injuries and damages.

Make sure that there is never building up overpressure or under pressure of more than 0.1 barg inside the entire line and that it is always open to the atmosphere! Otherwise, the device will get permanently damaged.

The line contains water steam and liquid water which can freeze and block the pipe. The pipe of each device and the common pipes for several devices must be sized appropriately and managed with an appropriate drainage system and good engineering practices to always allow bidirectional gas exchanges while still draining the water safely.

The operator must ensure that the outlet satisfies all relevant local safety guidelines, rules, directives, and regulations in terms of the safe dispersion of the vented gas, noise emission, risk assessments, maintenance, a satisfactory safety concept being utilized, and all other relevant areas.

It is the operator’s responsibility to regularly check and maintain all pipes.

Enapter is not responsible for any damage caused to the device from mismanaged piping arrangements.



To connect the port labelled “O₂ Vent”, use O₂, H₂, KOH and heat resistant pipes, sealings, and connectors only. If connecting several devices to a common vent line, make sure the diameter of the



line is sufficient and that it always runs at a downward angle. As water is condensing inside the vent lines, there must not be any horizontal or sagging sections. The water condensation would block the pipe. Pipes outside of the container or rack or far away from it are often facing colder temperatures and therefore more condensation which leads to a higher amount of liquid water. The lowest point of the vent line should therefore be located where the water condensation is accumulating. Bigger pipe diameters and low flow velocities help to drain condensed water safely.

At this lowest point with low flowrates where the condensed water is trapped, a drain trap or similar device must be installed to separate the condensed water from the oxygen (see picture).

Remember that each local lowest point, sagging or horizontal section requires an additional drain trap or similar device.

Make sure that water will not flow back to the devices. The vent outputs must not be the lowest points of the pipe.

The oxygen vent outlet must lead to a safe area with appropriate ventilation. For more information, see the section [Safety areas around the O2 vent and H2 vent outlet](#). The water from the water drainage system must be drained according to all relevant local safety guidelines, rules, directives, and regulations as it may contain traces of KOH.

We recommend leading the gaseous outputs from the oxygen vent to a safe area, described in the section "Implementing System Safety", and elevating the outlet to at least 3m above the electrolyser. If this is not possible, you may also manage the output in other ways, such as using a forced dilution of the output. <3>



Three EL4.1 and a DR2.1 with common O2 VENT



Details

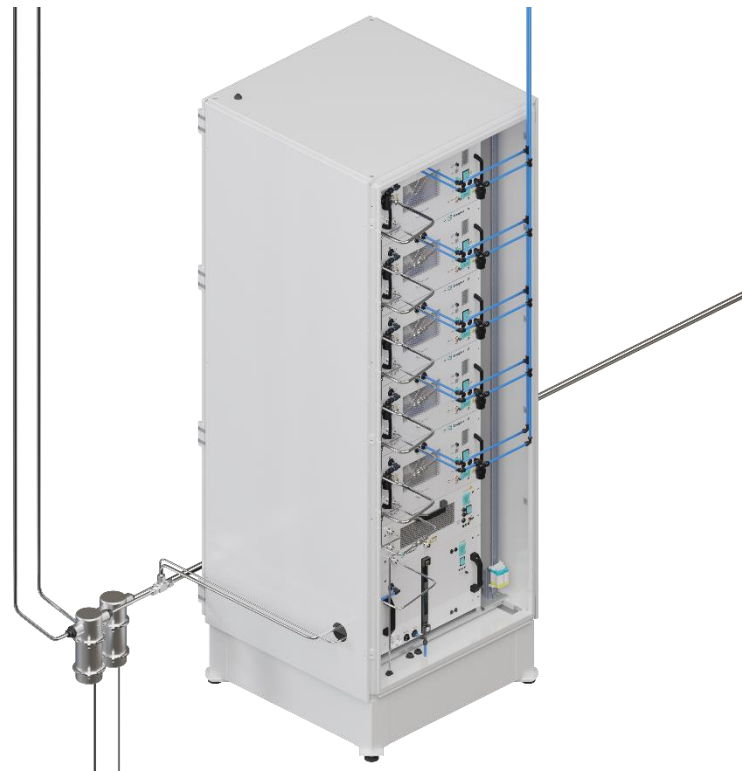

O₂ VENT line and water trap



Warning! Risk of explosion!

The gaseous outputs from the oxygen vent and the hydrogen vent must be kept separated. Mixing these outputs result in an explosive atmosphere.



4.6 INSTRUCTIONS FOR CONNECTING PLASTIC TUBES

Due to the fittings used on the device, the plastic tubes can be quickly assembled without additional tools. Clips prevent the tubes from being accidentally removed.



1. Cut the pipe perpendicular to the required length. Make sure that the pipes are not under tension. Ensure the pipe is free of score marks, the cut is perpendicular across the tube, and remove sharp edges. Properly clean and flush the pipes, especially if they have been in contact with dust, dirt, cutting particles, or liquids like oil. Fully insert the tube into the fitting. The inserted pipe diameter must match the fitting.
2. Pull the tube to check it is firmly held in place, then secure the connection by inserting a red fastening clip.
3. To disconnect, ensure that the line is depressurized. Then, remove the red fastening clip and push the collet against the fitting, while simultaneously pushing the tube into the fitting. Holding the collet in this position, pull the tube out of the fitting in one smooth motion.

4.6.1 WATER INLET CONNECTION GUIDE (H₂O IN)

The water inlet connector is a push-fit bulkhead for an outside pipe diameter of 10 mm. This inlet port is used for the automatic refilling of demineralized water from a pressurized source. If there is no water supply connected to this port during the electrolyte filling, the KOH concentration will not be matched.



EL4.1A H₂O IN and O₂ VENT



Notice! Overpressure can damage the device!

Ensure water pressure on the input line never exceeds the maximum allowed pressure. This can cause irreparable damage to the device and create significant leakages. Enapter is not responsible for any damage or injury resulting from the misuse of the device.



Notice! Insufficient water quality harms the device!

Ensure the water input quality is sufficient. Water with a high conductivity will irreparably damage the stack. The same applies for particles and debris in the demineralized water. Additionally, install a filter at the water inlet of the device (included in shipment) and clean it regularly to ensure that the water is free of particles. This filter does not affect the conductivity and cannot be used to replace the water purification system. Also ensure that the conductivity is always as low as possible. Otherwise change the cartridges of the water purification system immediately, **before** the device triggers a warning to replace the electrolyte. To reach a minimum number of necessary electrolyte exchanges per year, please follow the Water Input Quality recommendations in chapter 1.1 using ASTM D1193-06 Type II or Type III. If a device is damaged from using water with insufficient conductivity or debris, Enapter is not responsible for any damage caused.



Notice! Insufficient water pressure and interrupted water supply may harm the device!

Ensure the water pressure is sufficient. If the device cannot refill the internal tank due to insufficient water pressure or no water supply at all, the device may cycle additional times without any hydrogen production. A higher amount of ramp ups may decrease the stack lifetime.



Flush all water pipes with demineralized water before connecting the device to ensure no debris is in the lines. Then connect your water supply to the “H₂O IN” port located at the top left of the front panel. Install the filter, which is included in the shipment, close to the “H₂O IN” port to avoid debris from entering the device.

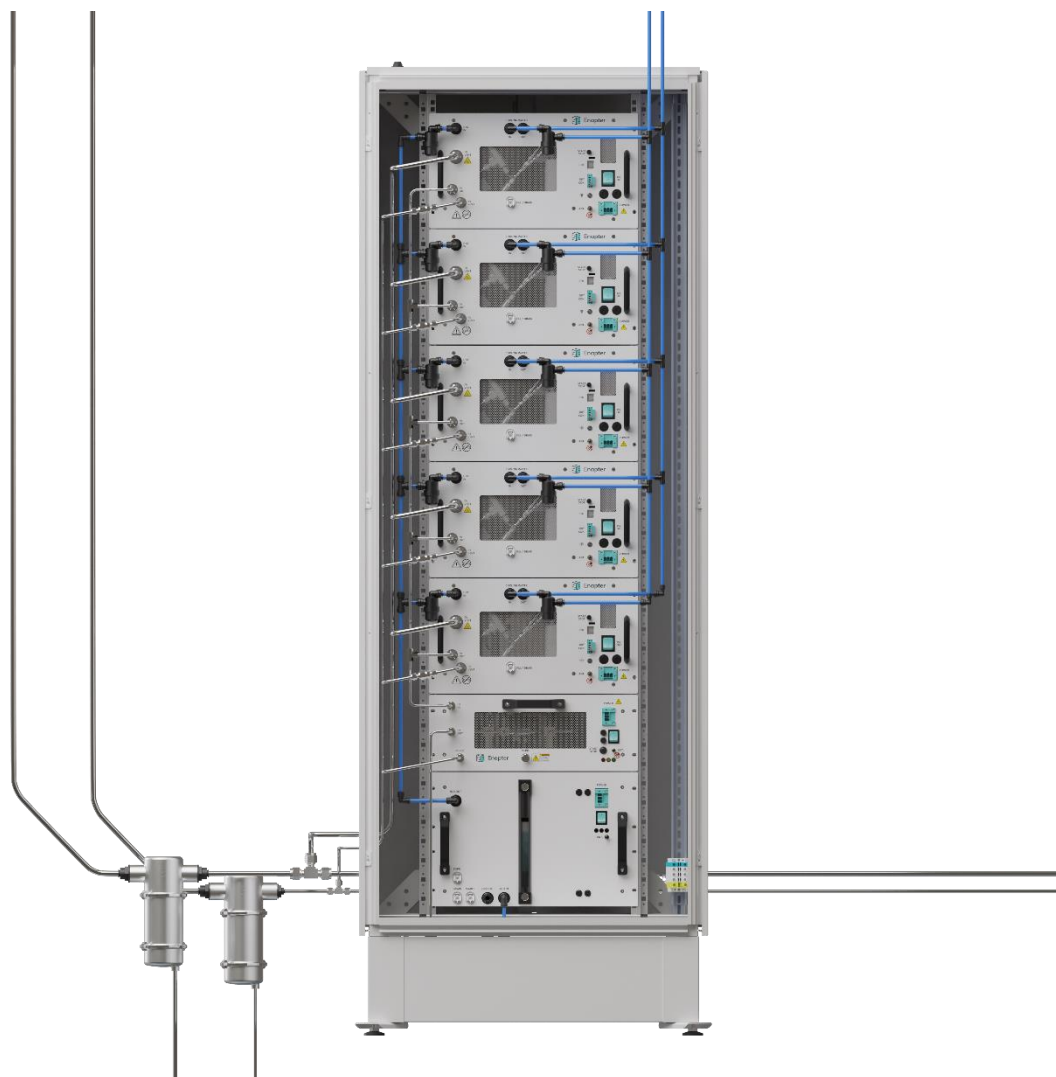

EL4.1 all pipes connected.

After performing the first [Electrolyte Filling](#) (filling the device with the supplied electrolyte solution), the device will consume water during operation at a rate of around 0.42 l/h. The refilling is triggered automatically from the “H₂O IN” port. This occurs periodically during operation, or directly after ramp down.



4.6.2 COOLING LOOP CONNECTION GUIDE (COOLING WATER IN/OUT)

For connecting the cooling loop of the liquid cooled electrolyser please consider the following instructions. For air-cooled devices, these instructions are not relevant.

Flush all water pipes with clean water before connecting the device to ensure no debris is in the lines. Only use components and materials which are compatible with the used cooling agent and with temperatures up to 60 °C.

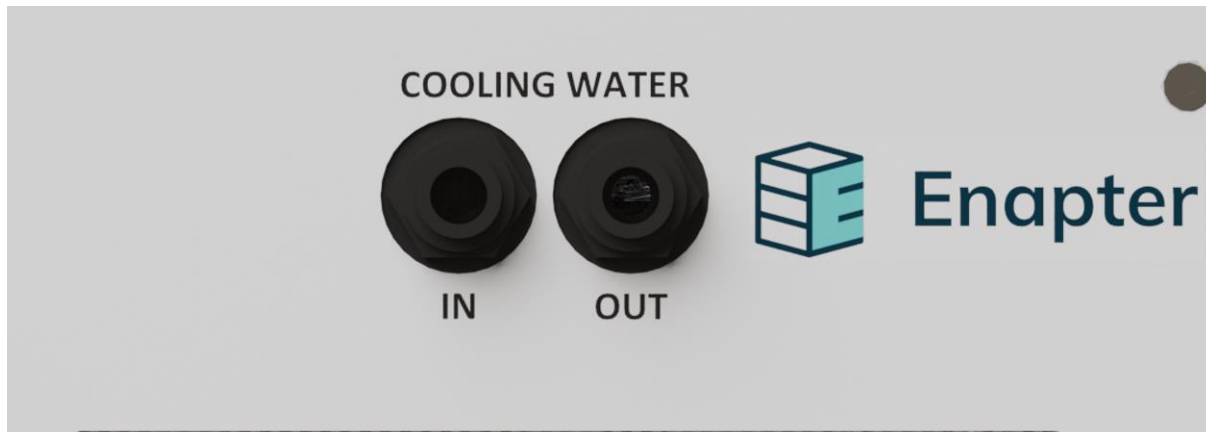

EL LC COOLING WATER IN and OUT

For the cooling of the device, Enapter recommends setting up a closed cooling loop using water or a water glycol mixture as a cooling agent. The cooling agent must be compatible with 1.4301 stainless-steel and POM (Polyoxymethylene), free of particles and be usable at up to 60°C. To further increase device reliability, install the filter supplied by Enapter on the cooling line inlet of the device. When the cooling agent is no longer showing the necessary physical and chemical requirements, is diluted, or shows any other form of degradation, it must be exchanged. At an external heat exchanger, the waste heat can either be transferred to another medium for further use or be dissipated to the ambient air by a fan. An external pump is needed to circulate the cooling agent. Please consider that the normally closed valve inside the device only opens when cooling is required.

The “COOLING IN” and “COOLING OUT” connectors are push-fit bulkheads for an external pipe diameter of 10 mm. Connect the ports, located on the top of the front panel, to your cooling circuit. When connecting several electrolysers to the same cooling loop, the electrolysers must be connected in parallel. Enapter recommends connecting a maximum of four to five electrolysers (respectively one cabinet) to the same cooling agent feed pipe in order to avoid high pressure drops and ensure equal cooling water flow to the individual electrolysers. If the pump is sized accordingly, several cooling agent feed pipes can be connected in parallel. The device has built-in flow restrictors of 2 L/min which help to balance the cooling liquid flow if more than one device is connected in parallel.

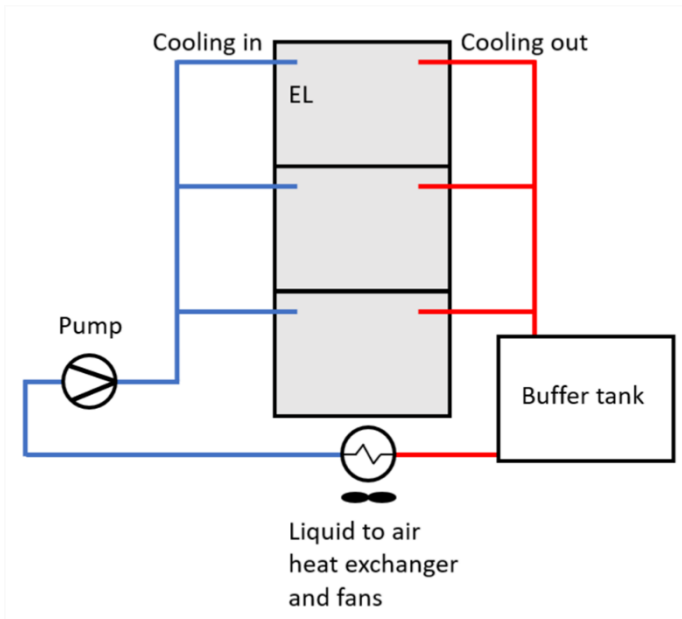

It is recommended to set up the cooling loop according to the schematic on the left. The return line (from the “COOLING OUT” port) should be connected to a non-pressurized coolant tank. This reduces back-pressure stresses on the valve inside the device and will prolong its lifetime. Connect the pump downstream of the external heat exchanger. When positioning it lower than the buffer tank, gravity can be used to feed the pump with cooling agent.

Cooling loop schematic



EL LC with filter

The external heat exchanger must be sized to be able to transfer up to 1000 W out of each electrolyser connected to the cooling loop.

The graph below indicates the operating range of the cooling circuit in terms of allowable inlet temperature of the cooling agent and the ambient temperature depending on the flow rate.

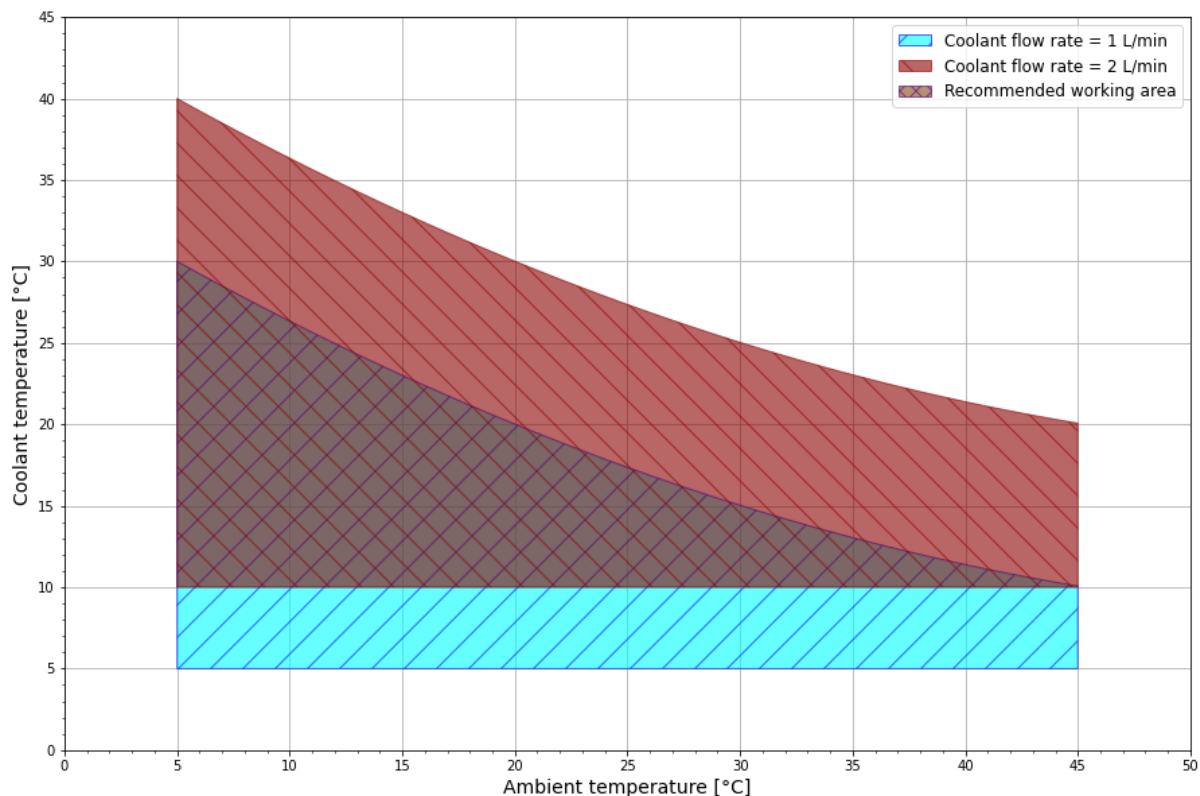

Possible cooling agent temperatures depending on the flow rate and ambient temperature.

The x-axis shows the environmental temperature, while the y-axis shows the coolant temperature. The graph differentiates between the following three sections: the top red one represents the possible working conditions if the coolant flow rate is at the maximum allowed 2 L/min; the light blue area instead shows the possible working conditions if the flow rate is at the minimum allowed value of 1 L/min. The section in between the two areas is defined as the recommended working area.

The flow rates shown refer to the instant flow rate per electrolyser. The cooling operation of the devices is intermittent so the average flow rate will be lower. Keep in mind that these values are based on water. When using another cooling agent with a different heat capacity, the required flow rate needs to be adapted accordingly. The pump used must be suitable for intermittent operation and able to build up pressure against the normally closed valve inside the device. The pump must be correctly sized to provide the necessary flow rate against the pressure drop induced by the piping and electrolysers. The maximum flow rate through one device is limited to 2 l/min by a flow restrictor. The pressure drop inside the device is around 0.25 barg for water and up to 0.35 barg for a glycol water mixture at 2 l/min. It is the operator's responsibility to correctly size the liquid-liquid/liquid-air heat exchanger and the cooling agent pump.

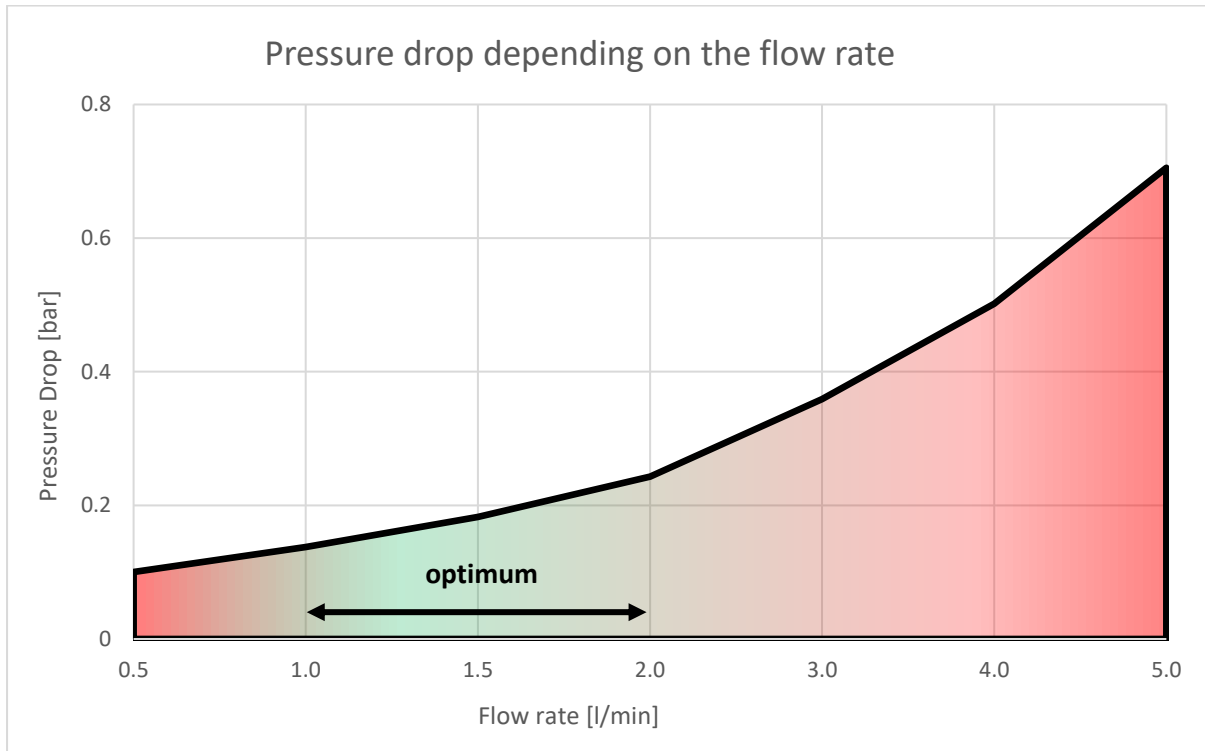

Pressure drop depending on the flow rate.

Please be aware that the device generates more heat as it degrades. At the beginning of life, a maximum of 490 W per electrolyser can be extracted from the electrolyte. At the end of life, this value increases to ca. 700 W per electrolyser. This waste heat can be available at up to 45 °C and can then be used for any customer-specific heating purposes.

Notice! Impurities can damage the device!



Ensure that the cooling agent pressure on the input line never exceeds 4 barg. Make sure that the cooling agent is filtered and free of particles. This can cause irreparable damage to the device and create significant leakages. Enapter is not responsible for any damage or injury resulting from the misuse of Enapter products.

Ensure the cooling agent pump can supply at least the minimum required flow rate. Shortage of cooling can cause irreparable damage to the device.



Three EL4.1 and a DR2.1 with common Cooling pipes

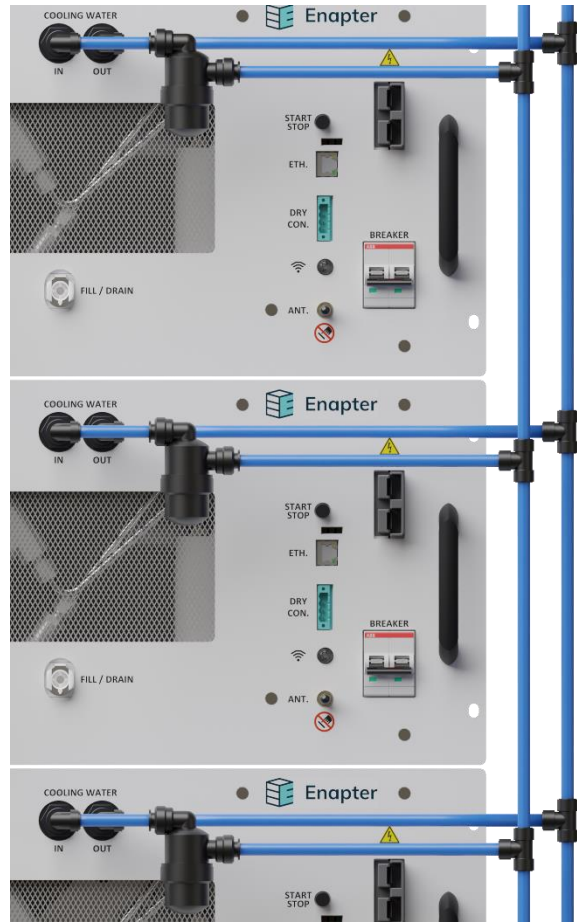

Details



4.7 ELECTRICAL CONNECTION GUIDE (POWER)

Warning! Explosion hazard. Do not remove or replace the power connector while circuit is live unless the area is free of ignitable concentrations!



Always turn off the device and fully ventilate the room first before removing the power supply. Otherwise, electric sparks may occur. The area must always be free of ignitable concentrations.

Warning! Risk of electrical shocks!



Double-check all the wiring connections before supplying power to the device. Failure to adhere to the following instructions can damage the device and lead to hazardous conditions in and around the device! Make sure that the power supply male connector is always fixed with screws to the female connector to avoid any accidental removal of the plug.

Never handle the electrical connections with wet hands!

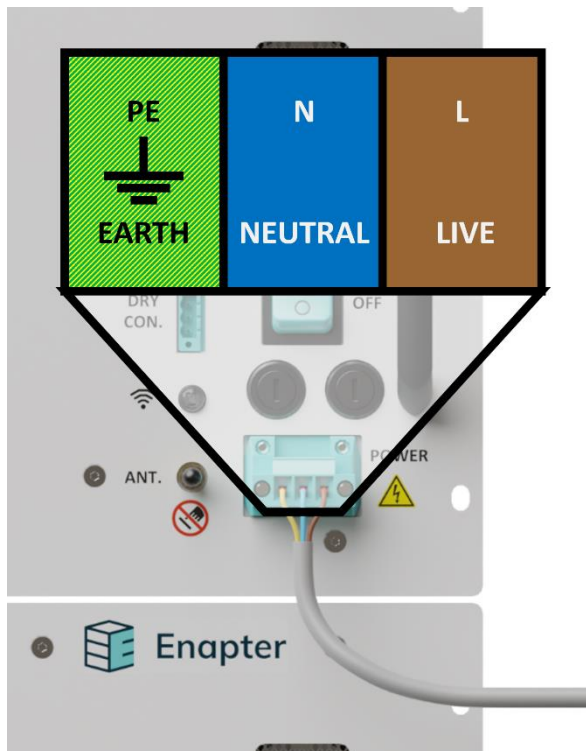

EL4.1 AC version power connector

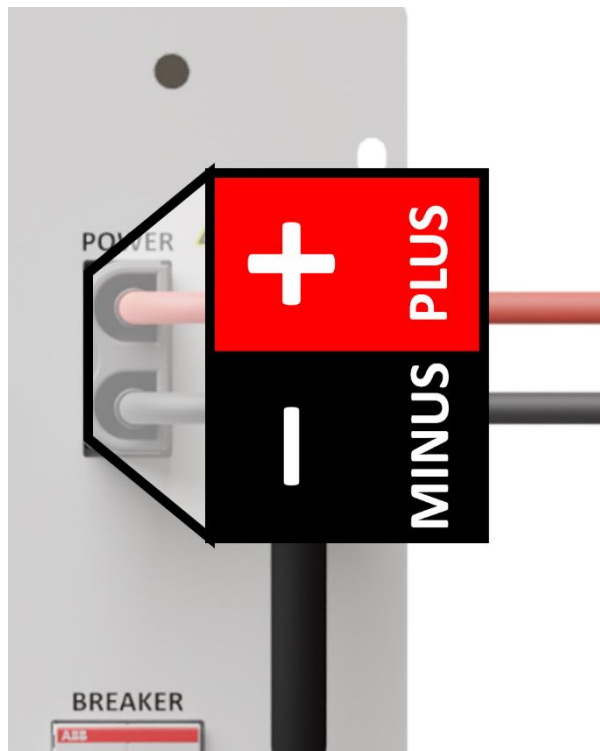

EL4.1 DC version power connector

Follow the relevant safety standards and ensure compliance with all relevant local safety guidelines, rules, directives, and regulations. Ensure that the connector is used in the correct orientation, as shown in the picture. Do not exceed the specified voltage and amperage (see [battery limits](#) for more details). Enapter recommends installing a protective device against overload and short circuits for all device versions on the power supply line. It must be selected in relation to the device’s maximum power consumption and in compliance with all local and national safety requirements. To further increase electrical safety of the device, it is recommended to install an SPD (Surge Protection Device) to protect



the device from potential over-voltages generated by lightning strikes, as well as an appropriately sized differential breaker for the installation.

4.7.1 AC VERSION

Connect the device to the socket labelled “Power”. Brown is live, blue is neutral, and yellow/green is the protective earth connection. The datasheet of the power supply plug can be found [here](#). See the [battery limits](#) for more details. The AC version of the device mounts two thermal overcurrent circuit breakers on the front panel which can be reset manually. <3>

In case the thermal switch opens the circuit, you can manually reset them by pressing the integrated button.

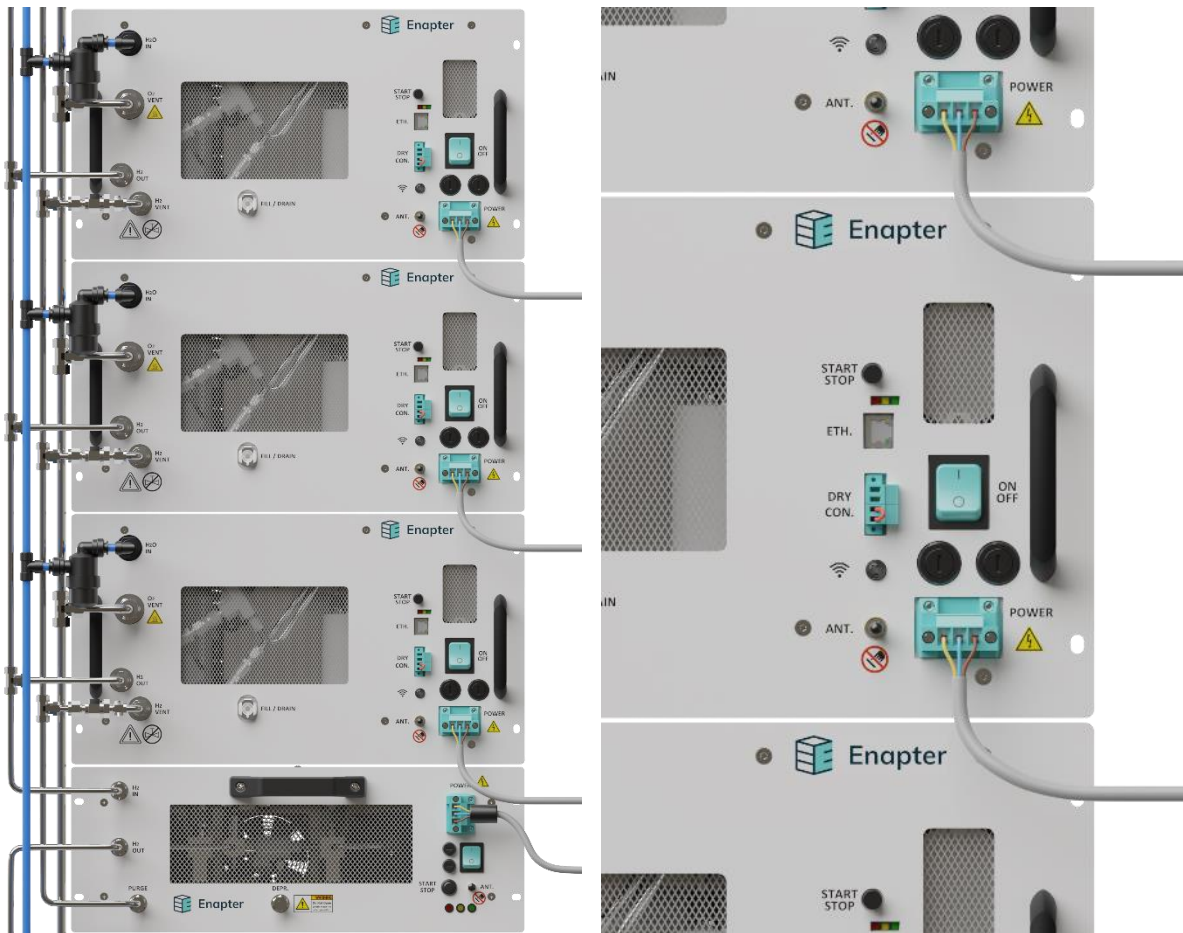

Three EL4.1 and a DR2.1 power supplied

Details

4.7.2 DC VERSION

The DC version has a 2-pins connector compatible with cross section cables of 16mm². The upper one is the positive voltage input (usually red cable). The lower one is the negative voltage input (usually black cable). See the [battery limits](#) for more details.



Caution! Wrong voltages can damage the device!



Do not exceed a maximum input voltage of 60V, even in cases of single fault. The device can be used with a floating input as well. In this case, the absolute voltage difference between chassis/earth and either of the power supply voltages must not exceed 100 V. The device must not be directly connected to a primary distribution network. A primary insulation must be placed in the installation upstream the device.

The DC version has a magneto thermic switch, which protects the device from overcurrent. Switch it to the upper position to power supply the device.

The chassis must be earthed separately to prevent contact with dangerous voltage and to allow the correct functioning of the device. The earthing system must comply with all relevant local safety guidelines, rules, directives, and regulations. Remove the screw and the washer from the labelled spot on the back side of the electrolyser and use them to connect the earth cable.

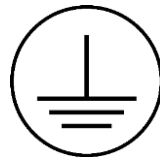

Earthing symbol on device

4.8 DRY CONTACT CONNECTION GUIDE (OPTIONAL) (DRY CON.)

The device has integrated dry contact sockets to allow emergency stops triggered by external devices e.g., a hydrogen sniffer or emergency stop switch. It is recommended to place this switch close to the devices so it can be identified that it will stop the system but not in a way that it is difficult to reach or be blocked by other devices or components. If no dry con chain needs to be integrated, please jump to the section below.

The cables of the input and the output (not part of the shipment) should be twisted. The ferrite provided with the device should be placed as close as possible to the output connection (upper slot) with a double turn, as shown in the picture.

Connect the male connector of the dry contact chain to the female port on the device, labelled “DRY CON”. The dry contact chain is closed during normal operation and opens in case of emergency. That means that an external safety device should show a “closed loop” during healthy state and an “open loop” in case of a warning or error.

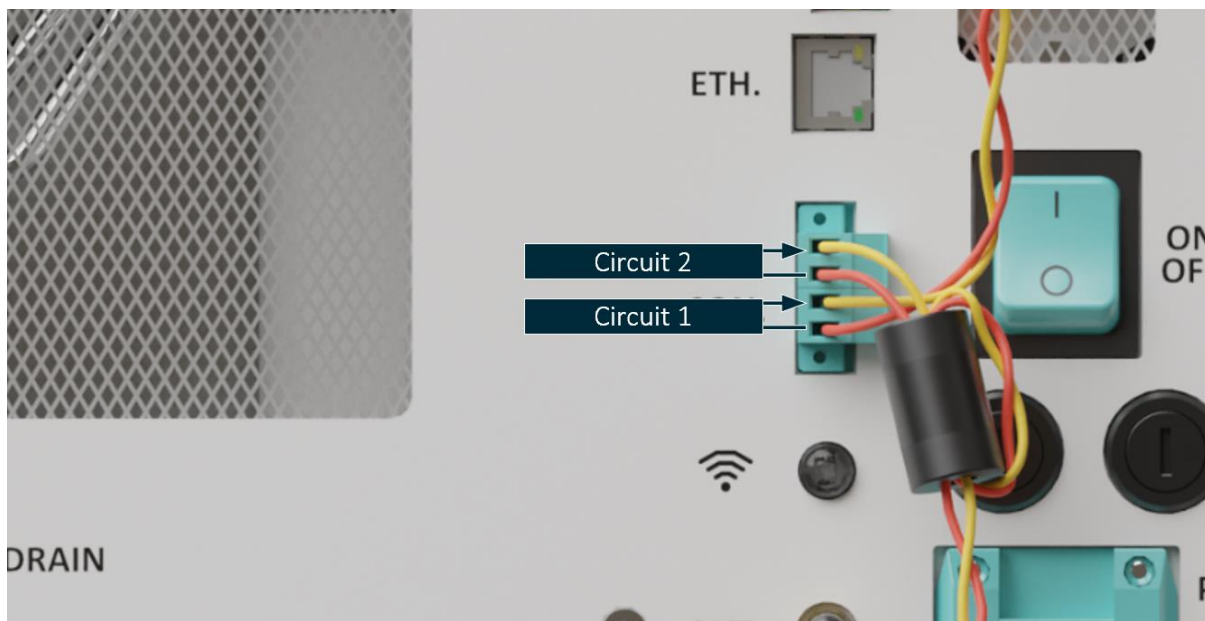

DRY CON circuit

The pins are, from top to bottom, S2, COM2, S1, COM1. This allows the device to not only receive a dry contact signal but also to pass it on to the next Enapter device. The operator can daisy chain as many Enapter devices as wanted to a common loop. To do that, connect a dry contact circuit to Circuit 1 (as shown in the picture), using the specially supplied plug. If the circuit is interrupted (i.e., the dry contact is opened), the device will immediately go into fatal error, stopping the hydrogen production, and release the internal hydrogen by venting it through the H₂ vent line.

Caution! The dry contact signal will not cut the power from the whole devices!

If the DRY CON is triggered, it will cut the power from the stack but not from the whole device. That means that the hydrogen production will be interrupted, but the device continues running.



If one electrolyser within the DRY CON daisy chain is switched-off, the chain is interrupted, and the emergency stop signal will not be transferred to the downstream devices

To implement the dry contact daisy chain, connect the two free contacts (Circuit 2) to the Circuit 1 of the nearest Enapter device. If the dry contact circuit is triggered by an opened contact, and all devices are switched on, they will stop their hydrogen production at the same time. **Dry contacts should not be used for normal start and stop operation.** Unexpected power cuts to the stack without normal ramp downs can shorten the device’s lifetime and damage the device!

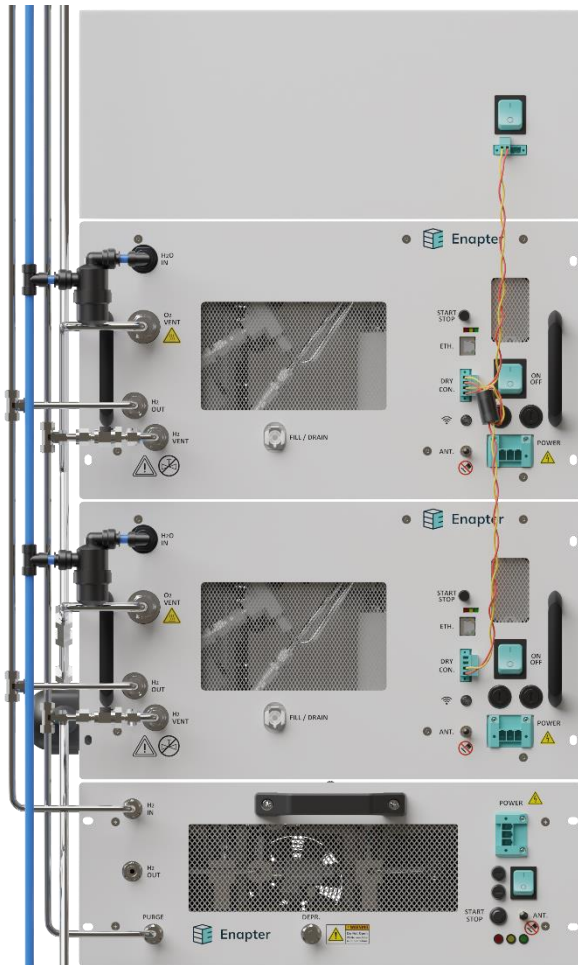

Dry Con daisy chain with two electrolyzers and Emergency Switch

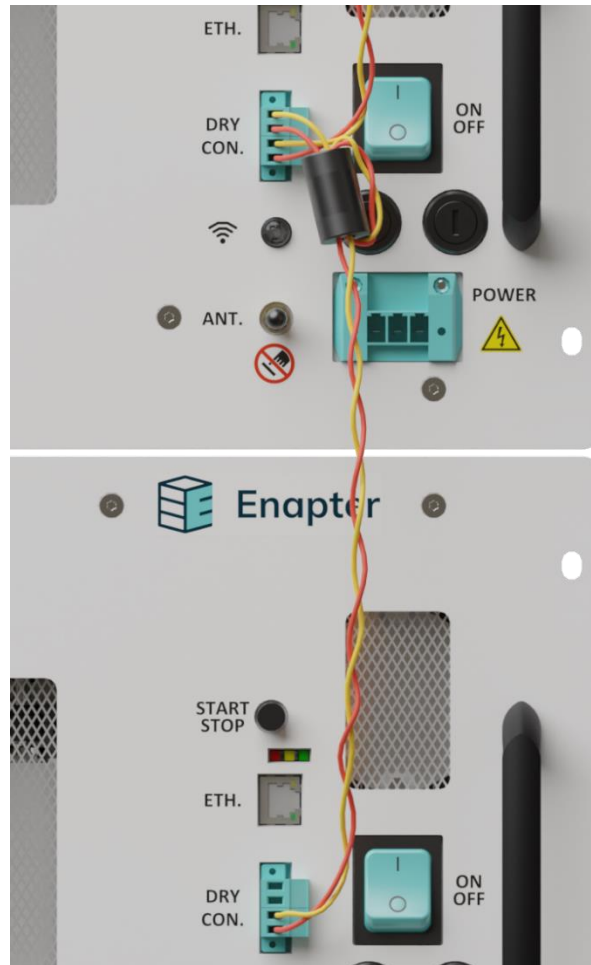

Details



4.8.1 DRY CONTACT CONNECTION BYPASS

To disable the dry con chain functionality, insert the dry con jumper with the red connection cable in the lower part of the socket labelled with “DRY CON” like shown in the picture.

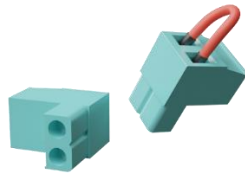

DRY CON jumpers

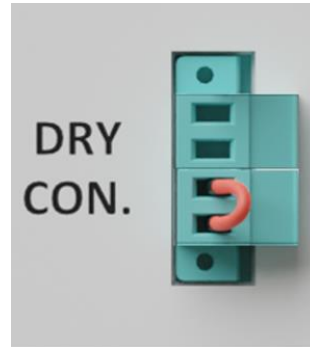

*DRY CON connector
with installed
jumpers*

4.9 ETHERNET PORT (ETH.)

The front panel features an ethernet port.

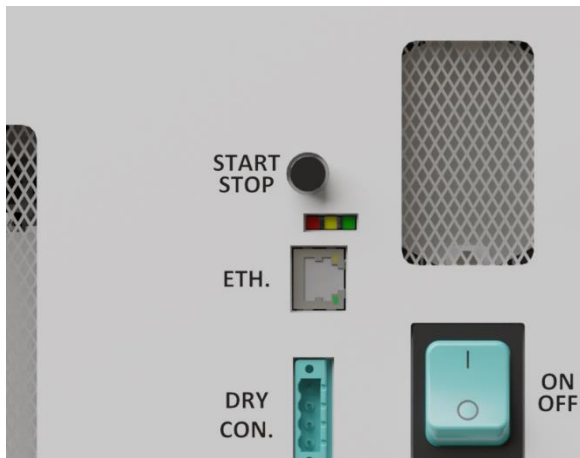

EL4.1 AC version Ethernet Connector

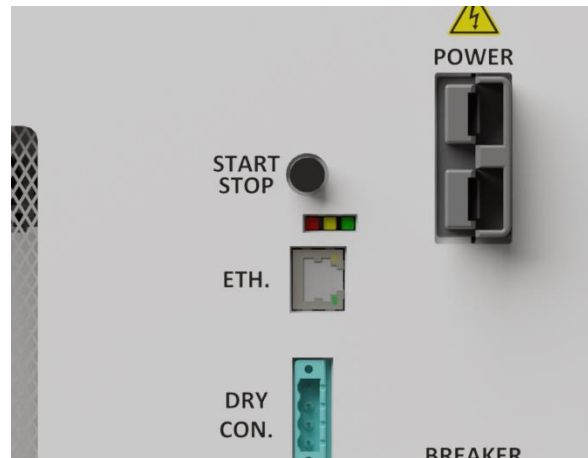

EL4.1 DC version Ethernet Connector

This Ethernet port allows Modbus TCP/IP access. The device cannot be directly connected to a Local Area Network (LAN) to access it via the cloud or app. To access the device via the cloud or app, WiFi and Bluetooth must be used. Please find more information in the chapter [Pairing the device to the cloud](#). The Modbus command interface table can be accessed online via [Enapter handbook](#). The Ethernet cable must be shielded.



4.10 ISO 22734 REQUIREMENTS

The device is ISO 22734 ready. To reach full conformity to ISO 22734 it is the operator’s responsibility to additionally fulfil the following requirements from ISO 22734 which cannot be covered by Enapter.

ISO 22734 chapter	Title	Deviation from the requirement and necessary changes from the operator
4.3.9 / by 4.3.3.2	Environmental tolerance of enclosure	The IP rating of this device is IP20. However, the ISO22734 requires: Where a hazard from ingress of solid foreign objects and/or ingress of water exists, as a minimum the hydrogen generator shall: a) meet the IP22 rating as defined in IEC 60529 for indoor, industrial use b) meet the IP34 rating as defined in IEC 60529 for indoor, residential use
4.4.1.4	Protection methods to prevent the accumulation of ignitable mixtures	Detection of hydrogen/air mixtures exceeding the maximum volume fraction of 1 % hydrogen shall cause hydrogen generation to stop and de-energization of non-classified electrical equipment. <4>
4.4.1.10	Venting system	H ₂ and O ₂ venting systems are not provided with the device and shall be designed and installed by the operator according to ISO 22734 requirements.

4.11 INITIAL OPERATION OF THE ELECTROLYSER

4.11.1 PREPARING FOR H₂ PRODUCTION

Now that the pipes and cables are connected, here is what to do next to get it running.

4.11.2 PAIRING THE DEVICE TO THE CLOUD

It is time to power on the device for the first time. Push the On/Off button (AC version) or switch the breaker at the top of the front panel in the upper position (DC version) to switch the device on. Press the Wi-Fi button and ensure that the blue LED is steady, which indicates that it is turned on. Make sure that the antenna is installed on the device for a more reliable WiFi connection.

Download the Enapter app from the Apple App Store or the Google Play Store. After installing, open the app. For detailed information about the app, please refer to the [mobile application handbook](#).

1. If you are using the application for the first time, you will need to register. If you already have an account, please skip this step.
 - ☰ To create an account, click on the create account button on the first screen.
2. After logging in on the Enapter app, create a site – a virtual environment which will show all the telemetries collected from the devices connected to the cloud via UCMs (Universal Communication Modules). UCMs for additional Enapter-external devices can be purchased via Enapter.



3. Add all your devices to the newly created site by clicking on “Add device” and scanning the QR code which is located on the front panel of each device.

4.11.3 ELECTROLYTE FILLING

When the device is connected to a water supply and to the Web GUI or Enapter app, it is now ready to be commissioned for its first use. Once it is successfully paired to the cloud, it starts in maintenance mode and gives prompts to perform the first-time filling.

If refilling the device during regular maintenance, it might be necessary to repeat the steps of draining and filling the electrolyte a few times. This ensures that contamination inside the tank is kept at a minimum, especially if the device has not been used for a long time. The Enapter app will automatically guide you through the process. Make sure to not overfill the device as this will cause irreparable damage. If the electrolyte does not fully drain, please contact the Enapter customer support team.

- Time required 5 minutes
- Safety Glasses
- Materials required Nitrile Gloves
- 2 L of KOH solution



To prepare the device for operation, before demineralized water is added automatically, it must be filled with the electrolyte which is included in the shipment. If it is not included following the repaired device, it can typically be procured or purchased locally. Please refer to Appendix II below.

Caution! Chemicals can cause injuries!



Refer to the Material Safety Data Sheet (MSDS) of all chemicals used before handling them. All persons using, preparing, and filling the electrolyte into the device must be informed about any potential hazards involved with their activities.



Follow industrial hygiene and safety practice and wear appropriate personal protective equipment (PPE). Avoid any contact with eyes and skin.



Notice! Ensure material compatibility.

Ensure all material used to store and contain the electrolyte solution is chemically compatible with its contents.



Notice! Overfilling the device will lead to irreparable damage inside the device!

Enapter is not responsible for any damage caused by the operator.



Push CPC connector in to connect



Push clip on top of socket and pull connector to disconnect

Filling instructions:

1. Make sure that the device is online to follow the Enapter App or use the Web GUI instructions to fill the device.
2. Put on PPE. The minimum required equipment are safety goggles to protect from splashes and nitrile gloves. Ensure the working area is clean to avoid chemical contamination and potential exposure hazards.
3. Temporarily remove the “O₂ VENT” pipe.
4. Make sure that the device is fully drained, otherwise it might get overfilled and damaged.
5. Prepare an electrolyte bag (i.e., the one shipped with the device) with 2 L of KOH solution as well as the refilling pipes.
6. Switch the device to the [Maintenance Mode](#) and ensure that the internal electrolyte tank is empty. If the device is not in [Maintenance Mode](#), it will try to refill while draining the device. To check if the device is in maintenance mode, please check the status in the cloud. Do not leave the device powered on and unattended while in [Maintenance Mode](#).
7. Screw off the original cap from the electrolyte bag and replace it with the threaded puncture seal cap. To connect the refilling pipe to the electrolyte bag, pull and hold the movable part of the connector and push it against the electrolyte bag.
8. Fully insert the supplied male CPC quick connector into the “FILL/DRAIN” port as shown in the left picture above.
9. If using the mobile app, press “Start refilling” now.
10. Carefully raise the electrolyte bag above the device so that gravity lets the 2 L of electrolyte flow into the device. Never lift the electrolyte above eye level. The solution will start filling immediately, if this does not occur, ensure the vent line is open to the atmosphere. Follow the steps provided by the app: pour the requested amount (2 L) until the app shows a pop-up to stop the filling process. This is roughly the size of the electrolyte bag.
11. If the app prompts you to stop, stop filling by lowering the bag below the electrolyser and unplugging the connector by pushing the button on top of the CPC connector. Do not overfill the device.
12. Confirm the successful refilling by pressing the button “Exit Maintenance Mode” in the app.
13. After the filling, the water supplied via the H₂O IN port will match the required KOH concentration of 1 % during the filling procedure. Make sure a water supply source is attached to the “H₂O In”



port when filling up electrolyte. If there is no water supply source available yet, the device will show a warning that no water supply source is attached. However, it is still possible to produce hydrogen for a few hours until the automatic refilling is triggered.

After the successful filling, the device will ask for a firmware update (if outdated). We recommend always using the latest firmware version to ensure all features are available and all bugs have been fixed. For questions regarding the firmware, please visit the [firmware section in the handbook](#).

The device will automatically refill water via the H₂O In port during hydrogen production. This happens periodically but not continuously. Do not leave the device powered on and unattended while in [Maintenance Mode](#).



5. OPERATION OF THE ELECTROLYSER

Before powering on the device, ensure the power cable and all pipes are properly connected and secured as described in this manual. Then, switch the breaker to the upper position.

5.1 MANUAL START/STOP

When the device is in standby mode, push the start/stop button, this will start the device. Remember that it may take several minutes to warm up, purging the humidity and ramping up before hydrogen flows out of the H₂ outlet.

To stop the device, simply push the start/stop button again. The device then ramps down and vents the contained H₂ to return itself to a safe state.



Notice! Properly shut down the device to avoid damage!

Do not unplug/disconnect the power to the device without, either manually or via software control, shutting it down safely first. Unexpected power cuts can shorten the device’s lifetime and damage it!

The device works most efficiently and is most durable when operating continuously. As with all electrochemical devices, the stack’s lifetime is shortened with frequent start/stops. Enapter recommends limiting the device’s operative cycles to a maximum of five on/off cycles per day, and one on/off cycle per hour. This helps to ensure the longevity of the device.

5.2 REMOTE START/STOP

The device can be started/stopped remotely using the Enapter app or cloud as well as remotely via the Modbus interface. For more information on this, please refer to the online Enapter handbook.

5.3 AUTOMATIC START/STOP

Once the device is started it will produce hydrogen until it measures 35 barg at the output of the H₂ Out port. The device will then go into standby (MAX_PRESSURE). If the pressure then drops again below 29 barg, the device automatically restarts the hydrogen production until 35 barg is reached again at the output. The maximum pressure of 35 barg and the restart pressure of 29 barg are the default values and can be adapted according to the operator’s needs.

To increase the lifetime of the device, it is strongly recommended to use an intelligent control system which automatically increases and decreases the production rate to keep steady pressure at the output or to adapt the production rate to the available power supply. Like this, the hydrogen production will be steadier, and the number of ramp ups and ramp downs will be reduced.



5.4 MAINTENANCE MODE

Maintenance mode can be manually enabled using the Enapter App. It is used to safely fill and drain the device, as well as to guide through inspection and other routine maintenance tasks. Please see the chapter [Routine Maintenance](#) to know more.

5.5 SET PRODUCTION RATE

Setting the production rate on the Cloud can be done in a very simple way on the main page of the electrolyser. On the "Commands" section click on the button "Set Production rate".

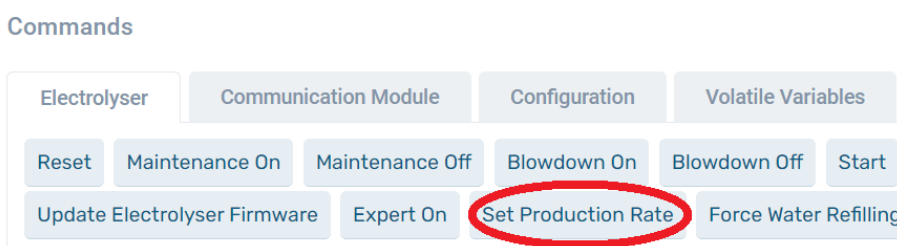

Enter a number between 60 and 100 to set the production rate to a desired percentage (60 % - 100 %). Then click on the button "Create Command". The production can be adapted in 1 % steps.

The screenshot shows a 'Details' form with a 'Value*' input field and two buttons: 'Create Command' and 'Cancel'.



Notice! The production rate will also be adapted with values outside of the range!

Please note that if a lower value is set (for example 50), the production rate will be set at the smallest possible value (60 %). Accordingly, higher numbers than 100 will result in 100 % production rate.

5.6 RAMP UP

The ramp up time of the device depends on the electrolyte temperature (the ramp up is slower at low ambient temperatures). Typically, the device will start with a hydration period of 60 seconds, and then ramp up to the nominal production rate with the following values:



- ≡ Warm-up time (time taken for the electrolyte to heat up to 55 °C):
The electrolyser can reach a heating ratio of 1 °C/min. If starting the device with an electrolyte temperature of e.g., 25 °C it will take about 30 min to be fully operational and perform at its maximum efficiency at 55 °C.
- ≡ Ramp up time (time to reach nominal production rate):
Usually, the 0.5 Nm³/h production rate is reached in about $\frac{2}{3}$ of the total warm-up time (the warm-up time is 30 min, so if starting at 25 °C, it will need 20 min to reach max production rate).
- ≡ Build pressure time:
The heat up and the hydrogen production start immediately. With standard set-points, the pressure is completely built in $\frac{1}{6}$ of the total warm up time (if starting at 25 °C, the warm-up time is 30 min, so it will need 5 min to build pressure).

During ramp up, the device performs periodical venting to guarantee high purity H₂ on the outlet, as well as to release condensed water from the produced H₂

5.7 RAMP DOWN

Like the Ramp Up, the Ramp Down slowly switches off the stack and the other components and moves the device into a safe state. The device should always be ramped down via the start/stop button or via the app/cloud to preserve the components. Switching it off via the breaker, the Dry-Con or switching off the power supply should be performed in cases of emergency only.

5.8 ANTI-FREEZING ROUTINE

The anti-freezing routine is an automatic routine which will check the temperature on the internal electrolyte tank to prevent the electrolyte from freezing. If the temperature is below 6 °C, the heater and circulation pump will be turned on. It switches off once the electrolyte reaches 10 °C again. This routine also checks the flow of the circulation pump and verifies that there are no obstructions in the inner piping system. The anti-freezing routine will not be active when the tank is empty.

5.9 PREHEAT FUNCTION

The preheat function allows the device to heat up in advance and therefore allow a faster ramp up. When activated, the device will automatically heat up the electrolyte to 45 °C. Once reached, it can immediately start hydrogen production.

5.10 SAFETY HEARTBEAT

The Safety Heartbeat functionality is a periodic signal transmitted between the device and the gateway to detect if the device is still connected to the cloud. If the device does not receive the signal anymore, it will undergo a normal ramp down. This allows the operator to always access the cloud data if the device is running. This feature is optional and can be switched off as well. Find further information on the Safety Heartbeat [in the handbook](#).



To activate the Safety Heartbeat via Gateway:

1. Connect the device to the [Gateway](#)
2. Configure [Safety Heartbeat](#) on the Gateway

To activate the Safety Heartbeat via Modbus, follow the [heartbeat instructions for Modbus](#).

5.11 TROUBLESHOOTING

The device can be continuously monitored and controlled remotely. This allows quick and easy detection of warnings and errors. The device will automatically stop the operation in case of a fatal error. For further troubleshooting, please visit handbook.enapter.com.

If the device shows a “Replace electrolyte” warning, please stop the H₂ production immediately and exchange the electrolyte (see section [Preparing fresh electrolyte](#)). It’s the operator’s responsibility to ensure that only water with very low conductivity is supplied to the device. Enapter recommends that the conductivity shall always be below 5µS/cm.

In case of a water leakage, please follow the instructions below to drain the water from the device.

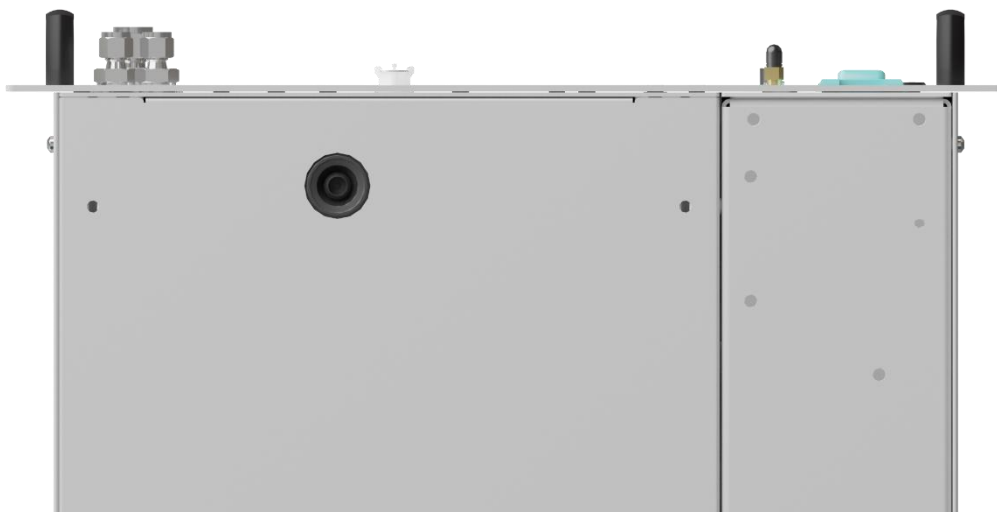

Drain Hole on the bottom of the device (view from the bottom)

Caution! The device contains chemicals!



Refer to the Material Safety Data Sheet (MSDS) of all chemicals used before handling them. All persons using, preparing, and filling the electrolyte into the devices must be informed about any potential hazards involved with their activities.



Caution! Protect yourself from splashes!



Mix the electrolyte solution in accordance with good industrial hygiene and safety practice and wear appropriate personal protective equipment (PPE) as specified by the relevant Material Safety Data Sheet (MSDS). Avoid any contact with eyes and skin.



1. The hole at the bottom of the device allows water and electrolyte inside the device to drain. To drain accumulated fluids, prepare a KOH resistant bucket of 3 L.
2. Put on personal protective equipment. The minimum required equipment are safety goggles to protect from splashes and rubber gloves.
3. Then carefully pull the device 10 cm out of the cabinet so that the hole can be easily reached.
4. Hold the bucket below the hole.
5. Push up the cap carefully. The fluid will drain immediately.
6. Finally, make sure that the hole at the bottom of the device is properly closed again.



6. ENAPTER MONITORING TOOLS

The device can be monitored and controlled remotely by authorized people by logging into Enapter’s cloud services on a web browser (<https://cloud.enapter.com/login>).

The device comes with a preinstalled UCM (Universal Communication Module) to monitor and manage the device. Various sensor data from the devices is stored in the Enapter Cloud in a time-series database and provides real-time or on-demand visualization of collected data on customizable dashboards. To support the latest protocols and security fixes, the UCM can be updated over-the-air.

Every device can be directly integrated with the Enapter Software-Defined EMS (Energy Management System). The UCM inside the device connects either directly to the Enapter Cloud, or via an Enapter Gateway which readies the device for Industry 4.0 – to find out more, please visit the [Enapter handbook](#).

Any operator of Enapter products can now integrate a wide range of devices and analogue inputs into the hydrogen production environment. System data of integrated devices is read continuously and is then securely transmitted to the cloud, which can be accessed from anywhere in the world via the [web interface](#) or with the Enapter mobile application.

After the setup of the device is finished, it can be managed via the mobile or web dashboard, which includes Automated Control and Monitoring functionality by customizable logic of the Enapter Rule Engine (requires an Enapter Gateway on the site).

6.1 MOBILE APPLICATION

Enapter’s mobile application makes the installation, monitoring and controlling of any energy system quick and easy. If any part of the hydrogen system encounters an issue, the mobile app can send push notifications to alert the operator. This functionality is available via Wi-Fi or mobile network, all over the world.

To find out more, please refer to the [Enapter handbook](#).



7. MAINTENANCE OF THE ELECTROLYSER

This device is designed to provide many hours of service with minimal and easy maintenance. Proper care and maintenance by qualified personnel help to maximize the operating life of the device. This section shall be read carefully and understood in conjunction with prescriptions given in the Safety Manual provided with the device. Leave enough space around the device to allow proper inspection, maintenance and cleaning.



Serious injuries and death as well as damages to the product or the environment possible! Follow the instructions in this manual carefully!

Ignoring the Safety Manual instructions could impair the safety functions performances.

7.1 UPDATES

Enapter provides firmware updates to include new functionality and to fix and improve system stability and performance. It is recommended to check for updates using the mobile phone app or the cloud web interface regularly and install them. In some cases, interfaces or compatibility with other devices might change due to an update. To make sure that an update is not negatively affecting the overall setup, please read the release notes beforehand and inform the Enapter customer support team in case of doubts.

7.2 ROUTINE MAINTENANCE

The device should be inspected at least once a year for apparent signs of physical deterioration. All hydrogen connections must be tested for leakages regularly; Enapter recommends using one of the techniques listed in the [Hydrogen Leak Testing](#).

Additionally, the Proof-tests described in the Safety Manual must be executed successfully once per year. For more information, please look at the Safety Manual or contact the Enapter customer support team.

After commissioning, the process tank must be emptied at least once a year and new electrolyte filled into the device. For more information, please refer to [Draining the electrolyte](#), which details the draining process of the device, and then follow the instructions for the [Electrolyte Filling](#). It is recommended to clean the device at the same time as described in the chapter Cleaning.

Depending on the frequency of use, it is possible that the process tank needs to be emptied and refilled more often than once a year. By connecting the device to the cloud, it is possible to receive alerts when the device voltages start increasing – this typically signifies a needed electrolyte change. After the electrolyte change, the electrolytic stack will return to a lower voltage, decreasing power consumption of the device and increasing its efficiency and lifetime.



Caution! Only authorized maintenance!

Any maintenance activities, excluding the ones listed in the Routine Maintenance and installation sections, are only allowed to be performed by trained technicians!

Warning! Explosion hazard. Do not remove or replace antennas, lamps, plug-in modules (as applicable) or other components unless the power has been disconnected or the area is free of ignitable concentrations!



Always turn off the device and fully ventilate the room first before removing the power supply. Otherwise, electric sparks may occur. The area must always be free of ignitable concentrations.



Shut down the device, remove the power, and wait until the device is cooled down before working on it in any way.



Always wear PPE during the maintenance of the device.
Do not open the device!



During maintenance, avoid heat in the vicinity of the device and the hydrogen source.
No smoking, no naked flames.

Prevent electrostatic charging of the device.

Before starting to work on the device, ensure being aware of all relevant local health and safety guidelines, rules, directives, and regulations, as well as action plans if an accident occurs.

7.2.1 FLUSHING THE ELECTROLYTE TANK

When the device has been drained during maintenance, it might request a flushing process via the Enapter App. Keep the device in maintenance mode while observing it in the Enapter App or the Web GUI. The flushing process will use purified water from the H₂O In port to flush the internal tank. Once the process is finished, the internal tank must be filled with fresh electrolyte. Follow the instructions below to flush the internal tank, remove remaining old electrolyte, and therefore increase the lifetime of the device.

1. Put on PPE. Minimum Equipment Requirements are nitrile gloves and safety goggles to protect yourself from splashes. Ensure your working area is clean to avoid chemical contamination and potential hazard exposure.
2. Connect the device to the Enapter App and open its dashboard (or access the Web GUI).
3. Enable the Maintenance mode using the Enapter App or Web GUI.
4. Prepare a container and insert the end of the draining pipe into it.
5. Fully insert the other end of the draining pipe into the FILL/DRAIN port. The drained electrolyte will start pouring out immediately.
6. Disconnect the draining pipe from the FILL/DRAIN port by pressing down the button on the port once the app shows an empty tank. Then follow the steps in the app to initiate the flushing process (filling) of the device.
7. Once the internal tank is filled, prepare a second container and insert the end of the draining pipe into it.



8. Fully insert the other end of the draining pipe into the FILL/DRAIN port. The water which is now mixed with the remaining electrolyte will start pouring out immediately.
9. Disconnect the draining pipe from the FILL/DRAIN port by pressing down the button on the port.
10. Confirm that the flushing has been finished (draining) by pressing the “Continue” button in the app or Web GUI.
11. The device now is ready to be filled with fresh electrolyte. Please see the chapter [Electrolyte Filling](#) for more information.

7.3 5-YEAR MAJOR MAINTENANCE

The device contains a safety system which allows advanced monitoring of safety critical components and further improves the safe operation of the device. To ensure that the safety system works properly, the device needs to be inspected by Enapter or one of its authorized service partners every five years (mission time) for major maintenance. More details can be found in the Safety Manual.

It’s the operator’s responsibility to request the major maintenance within the mission time and to book a time slot for the inspection. For more information as well as for requesting the major maintenance, please contact the Enapter customer support team.



Caution! Only authorized maintenance!

The 5-year major maintenance activities described in this section are only allowed to be performed by Enapter or authorized service partners!



Warning! Explosion hazard. Do not remove or replace antennas, lamps, plug-in modules (as applicable), or other components unless the power has been disconnected or the area is free of ignitable concentrations!

7.4 CLEANING

When performing the routine maintenance processes and checks, the device should be inspected and cleaned. Start by carefully using a vacuum cleaner (not included) to clean out the ventilation openings/grills. Afterwards, use a damp cloth (no acids, aggressive, or abrasive substances) to clean the outside of the device.



Caution! Unplug device before cleaning!

Remove the supply of power before cleaning the device. Never handle the electrical connections with wet hands. Ensure the device is dry before returning the supply of power to it.



Notice! No internal cleaning necessary!



The internal components of the device do not need to be cleaned and must not be accessed by the operator for cleaning.



Only trained and authorized personnel is allowed to open and inspect the device for maintenance reasons.

7.5 DISPOSAL



Enapter is fully committed to recycling the devices and their components.

Please return the device to Enapter at the end of life, when the device will be fully recycled.

By ensuring this product is correctly recycled, you will help to further reduce your impact on the environment and aid us in making the world cleaner and greener.

7.5.1 DRAINED ELECTROLYTE

Before draining the device through its dedicated port, wear appropriate personal protective equipment (PPE). For more information, refer to [Appendix III](#) below. Collect the electrolyte in an appropriate container and place it in a chemical waste container. It contains up to 2 % of KOH <4> if filled according to this manual.

Please protect the environment: Do not flush into the sewer. Dispose of the liquid in compliance with all relevant local safety guidelines, rules, directives, and regulations.

7.5.2 BUTTON CELL OR COIN BATTERY

The electrolyser contains a non-replaceable battery.

- Battery type: Lithium battery, CR2032
- Nominal Voltage: 3V

Please observe the following:

- Remove and immediately recycle or dispose of used batteries according to local regulations and keep away from children. Do NOT dispose of batteries in household trash or incinerate.
- Even used batteries may cause severe injury or death
- Call a local poison control center for treatment information
- Non-rechargeable batteries are not to be recharged
- Do not force discharge, recharge, disassemble, heat above (manufacturer's specified temperature rating = 85°C) or incinerate. Doing so may result in injury due to venting, leakage or explosion resulting in chemical burns <4>

1.1 TRANSPORT

For returns within warranty, repairs or recycling, please report your device issue to the Enapter customer support team to receive the Return Material Authorization form and the packaging instructions.



Before transport, verify that the device is completely cooled down and that the electrolyte tank has been emptied according to [Draining the electrolyte](#). Seal the connections on the front panel by inserting the red plugs that were supplied with the device into their respective bulkheads and place the plastic caps on the hydrogen outlet and vent lines. Ensure the device is transported in an upright position, and that an indicator for this is clearly visible on the outside of the packaging.



Notice! Use original shipping material only!

Enapter may not accept the device if returned without the original shipping boxes or equivalent for safe transport. If damage occurs during the return of a device under warranty, Enapter will not cover the costs of repair.



Caution! The device is heavy!

Never lift a device alone, as it weighs over 40 kg. Use lifting aids if available.



Due to their weight and size, it is recommended to use a pallet cart or similar devices to maneuver the box upon delivery. If the box must be lifted, always lift it with at least two people.



Notice! Do not exceed the allowed temperatures!

During winter, or when outside conditions are below freezing temperature as well as for very hot environments, the shipping box must be additionally marked with a label informing the shipping agent that the package may not be exposed to temperatures outside of the given storage temperatures stated in the datasheet.



2. APPENDIX

Appendix I. Hydrogen Leak Testing

As part of a hydrogen device, it is of vital importance to check every connection made for leaks. For more information on this matter, please refer to the appendix of ASME B31.12.

There are three main ways recommended to check for leaks:

1. Surface hydrogen detection
2. Soap bubble testing
3. Pressure drops testing.

Surface hydrogen testing

Using a calibrated hydrogen sniffer, slowly check for leaks around each connection.

PROS

- ≡ Precise, it can pinpoint even small leakages.
- ≡ Can grade leakages according to leakage rates

CONS

- ≡ Does not work when there are elevated levels of hydrogen in the atmosphere

Soap bubble testing

Using a mixture of soap and water (please ensure the soap used is compatible with the device and the materials used), the solution is dropped on individual connections using a small pipette. If the connection bubbles, a leak is present.

PROS

- ≡ Can be fast for larger leaks on small parts when testing multiple at one time.
- ≡ Low-cost
- ≡ Best method for detecting exact leak location detection.
- ≡ Accurate, it works even with elevated background H₂ levels

CONS

- ≡ Cannot detect tiny leakages.
- ≡ No leak rate or test result information
- ≡ Slow: Detecting small bubbles on typical parts can take much longer than other methods.
- ≡ Risky: An extremely operator dependent technique with a high possibility of passing actual failures.

Pressure drop testing

This test is performed by isolating individual sections of a pipe while monitoring the pressure contained within over time and should be performed at the maximum operating pressure of the device. If a drop in pressure is observed, which cannot be attributed to changes in temperature, a leak exists.

PROS

- ≡ Useful for final verification during device commissioning

CONS

- ≡ Cannot detect exact leakage source.
- ≡ Cannot grade leakage rates accurately



- ≡ Can verify several connections at the same time

Appendix II. Preparing fresh electrolyte

Time required	5-10 minutes
	Safety Glasses
Materials required	Nitrile Gloves
	Clean 5L container
	2 L of demineralized water (please refer to the Water Input Quality in chapter 1.1)
	Chemical scales
	40 g (+/-0.3 g) of KOH (85% purity) (CAS-N°:1310-58-3 ¹)



For routine maintenance, a new electrolyte solution must be prepared. Regular changing of the electrolyte in the electrolyser helps to prolong the lifetime of the device. If the device has been filled with water which did not fulfill the required purity, the electrolyte must be exchanged as well. Fresh electrolyte or the necessary KOH granulate can usually be purchased locally.

Caution! The device contains chemicals!



Refer to the Material Safety Data Sheet (MSDS) of all chemicals used, before handling them. All persons using, preparing, and filling the electrolyte into the devices must be informed about any potential hazards involved with their activities.



Caution! Protect yourself!



Mix the electrolyte solution in accordance with good industrial hygiene and safety practice and wear appropriate personal protective equipment (PPE) as specified by the relevant Material Safety Data Sheet (MSDS). Avoid any contact with eyes and skin.



Notice! Chemicals might damage the device!

Carefully read the instructions below before starting. Follow the instructions carefully and contact the Enapter customer support team in case of questions.

Ensure all material used to store and contain the electrolyte solution is chemically compatible with its contents.

¹We recommend contacting Enapter to make sure that the purchased product is compatible (support@enapter.com)



1. Put on PPE. The minimum required equipment are safety goggles to protect from splashes and nitrile gloves. Ensure the working area is clean to avoid chemical contamination and potential exposure hazards.
2. Ensure the selected KOH resistant container is large enough to contain the solution entirely. Verify the container is clean, and no debris is visible inside. If you are unsure – go to step 3, otherwise, skip to step 4.
 - ≡ If you are preparing the solution in advance – clearly mark and label the solution. Keep out of the reach of children and untrained people. Never store chemicals above eye-level.
3. Thoroughly rinse the container with demineralized water, at a minimum of three times. Before continuing to step 4, perform another visual check to see if any other debris may be visible.
4. Fill 2 L of demineralized water into the KOH resistant container (please refer to the Water Input Quality in chapter 1.1).
5. Carefully weigh the required amount of KOH. Add 40 g (+/-0.3 g) of KOH (with 85 % purity) into 2 L of demineralized water to create the KOH solution.
 - ≡ **Attention:** Do not use KOH with less than 85 % purity. Adjust the amount of KOH pellets according to the KOH purity.
6. Fill the KOH into the container with the demineralized water. **The solution will get warm!** Immediately stir the solution or mix it around the container with the lid firmly closed.

Appendix III. Draining the electrolyte

Time required 5-10 minutes
Safety Glasses

Materials required Nitrile Gloves
Clean 5L container



The module must be drained for transport, installation, and before the routine changing of the electrolyte in the device to prolong its lifetime. To do this, the device must be first switched into Maintenance Mode using Enapter mobile app or cloud. Follow the steps outlined in the app or use the instructions below.

Collect the liquid in an appropriate container and place it in a chemical waste container. Do not flush into the sewer! Dispose of the liquid in compliance with all relevant local safety guidelines, rules, directives, and regulations.



Caution! The device contains chemicals!



Refer to the Material Safety Data Sheet (MSDS) of all chemicals used before handling them. All persons draining and handling the electrolyte from the devices must be informed about any potential hazards involved with their activities.



Caution! Protect yourself!

Wear appropriate personal protective equipment (PPE). Avoid any contact with eyes and skin.



If you got in contact with the drained solution, immediately wash the affected area and refer to the material safety data sheet of potassium hydroxide and potassium carbonate.

Notice! Chemicals might damage the device!



Carefully read the instructions below before starting. Follow the instructions carefully and contact the Enapter customer support team in case of questions.

Ensure all material used to store and contain the electrolyte solution is chemically compatible with its contents.

1. Put on PPE. The minimum required equipment are safety goggles to protect from splashes and nitrile gloves. Ensure the working area is clean to avoid chemical contamination and potential exposure hazards. Enable maintenance mode using the Enapter App.
2. Attention: the device should be kept powered on, if possible.
3. Prepare the container to catch the drained liquid and insert the end of the drainpipe into it.
4. Take out any tube or fitting attached to the "O₂ VENT" to let the air fill into the tank when the solution is drained.
5. Fully insert the supplied male CPC quick connector into the valve bulkhead labelled "FILL/DRAIN". The solution will start pouring out immediately. Place the container below the port to fully drain the electrolyte.
6. Collect the drained liquid in an appropriate container and place it in a chemical waste container. Do not flush into the sewer. Dispose of the liquid in compliance with all relevant local safety guidelines, rules, directives, and regulations.
7. Once electrolyte stops pouring, safely remove the drain connector. To disconnect, push the button and pull the connector out of the bulkhead.
8. If the electrolyte is drained for maintenance, be aware that fresh water will be filled up via the "H₂O IN" port. The app guides you through the necessary steps. After the refill, more drains and refills will be needed until the electrolyser can be filled up again with electrolyte.



Appendix IV. LED Status



EL4.1 AC version LEDs

DR2.1 LEDs

The three LEDs on the front panel help to indicate the device status and operating condition. During normal operation, the LEDs indicate the status of the device. Please visit the Handbook for the LED status indication of the [electrolyser](#) and the [dryer](#).



Appendix V. Error Codes

[Here](#) you can find a list of all the warnings and errors that can be triggered while using the electrolyser. The list covers all firmware versions.

The warning and error codes for the DR21 can be found [here](#).

Check which firmware is installed on the device and then choose “Modbus TCP Communication Interface” and then “Warning, Error and Fatal Error Codes” to access all warning and errors. E.g. the warnings and errors for the electrolyser’s firmware [can be found here](#).

Appendix VI. Water Specifications

Verify that your input water conforms to at minimum the requirements laid in ASTM D1193-06, Type 4, as well as the following extra specifications:

Total Organic Compounds (TOC) <1000 ppb

Total Silica < 500 ppb

Acidity < 0.1 meq/L (according to D1067)

Conductivity <5µS/cm

To ensure minimal maintenance and optimal operation, we highly advise that the water you use respects ASTM Type 2 or Type 3. This measure helps to extend the duration between necessary electrolyte replacements.